

TMP451 $\pm 1^\circ\text{C}$ Remote and Local Temperature Sensor With η -Factor and Offset Correction, Series-Resistance Cancellation, and Programmable Digital Filter

1 Features

- $\pm 1^\circ\text{C}$ Accuracy for Local and Remote Diode Sensors
- 0.0625°C Resolution for Local and Remote Channels
- 1.7-V to 3.6-V Supply and Logic Voltage Range
- 27- μA Operating Current, 3- μA Shutdown Current
- Series Resistance Cancellation
- η -Factor and Offset Correction
- Programmable Digital Filter
- Diode Fault Detection
- Two-Wire and SMBus™ Serial Interface
- 8-Lead WSON (WDFN) Package

2 Applications

- Processor and FPGA Temperature Monitoring
- Smart Phones and Tablets
- Servers, Desktops, and Notebooks
- Telecom Equipment and Storage Area Networks (SANs)

3 Description

The TMP451 device is a high-accuracy, low-power remote temperature sensor monitor with a built-in local temperature sensor. The remote temperature sensors are typically low-cost discrete NPN or PNP transistors, or substrate thermal transistors or diodes that are integral parts of microprocessors, microcontrollers, or FPGAs. The temperature is represented as a 12-bit digital code for both the local and remote sensors, giving a resolution of 0.0625°C . The temperature accuracy is $\pm 1^\circ\text{C}$ (maximum) in the typical operating range for the local and the remote temperature sensors. The two-wire serial interface accepts the SMBus communication protocol.

Advanced features such as series resistance cancellation, programmable nonideality factor (η -factor), programmable offset, programmable temperature limits, and a programmable digital filter are combined to provide a robust thermal monitoring solution with improved accuracy and noise immunity.

The TMP451 device is ideal for high-accuracy temperature measurements in multiple locations and in a variety of automotive subsystems. The device is specified for operation over a supply voltage range of 1.7 V to 3.6 V and a temperature range of -40°C to 125°C .

Device Information⁽¹⁾

PART NUMBER	PACKAGE	BODY SIZE (NOM)
TMP451	WSON (8)	2.00 mm x 2.00 mm

(1) For all available packages, see the orderable addendum at the end of the data sheet.

Simplified Schematic

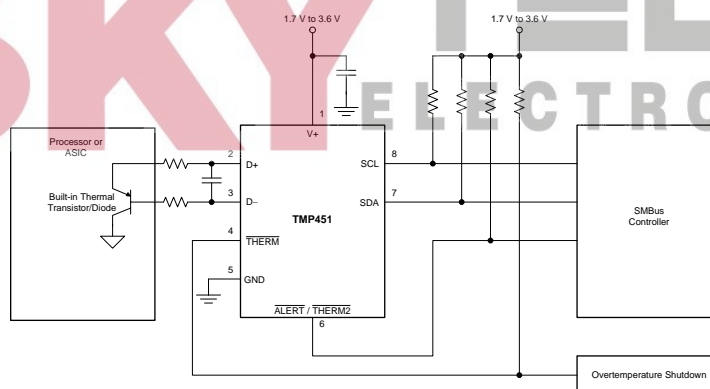

Table of Contents

1 Features	1	7.3 Feature Description.....	8
2 Applications	1	7.4 Device Functional Modes.....	12
3 Description	1	7.5 Programming.....	12
4 Revision History	2	7.6 Register Map.....	16
5 Pin Configuration and Functions	3	8 Application and Implementation	29
6 Specifications	3	8.1 Application Information.....	29
6.1 Absolute Maximum Ratings	3	8.2 Typical Application	29
6.2 ESD Ratings.....	3	9 Power Supply Recommendations	32
6.3 Recommended Operating Conditions.....	4	10 Layout	32
6.4 Thermal Information	4	10.1 Layout Guidelines	32
6.5 Electrical Characteristics.....	4	10.2 Layout Example	33
6.6 Timing Requirements	5	11 Device and Documentation Support	34
6.7 Typical Characteristics	6	11.1 Trademarks	34
7 Detailed Description	8	11.2 Electrostatic Discharge Caution.....	34
7.1 Overview	8	11.3 Glossary	34
7.2 Functional Block Diagram	8	12 Mechanical, Packaging, and Orderable Information	34

4 Revision History

Changes from Original (June 2013) to Revision A	Page
<ul style="list-style-type: none"> Added <i>ESD Ratings</i> table, <i>Feature Description</i> section, <i>Device Functional Modes</i>, <i>Application and Implementation</i> section, <i>Power Supply Recommendations</i> section, <i>Layout</i> section, <i>Device and Documentation Support</i> section, and <i>Mechanical, Packaging, and Orderable Information</i> section 	3



5 Pin Configuration and Functions

**DQF Package
8-Pin WSON
Top View**

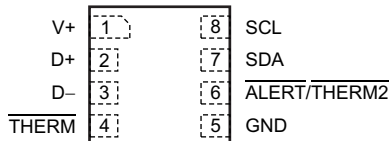

Pin Functions

PIN		TYPE	DESCRIPTION
NAME	NO.		
ALERT/THERM2	6	Digital output	Interrupt or SMBus alert output. Can be configured as a second THERM output. Open-drain; requires pullup resistor to voltage between 1.7 V and 3.6 V.
D–	3	Analog input	Negative connection to remote temperature sensor.
D+	2	Analog input	Positive connection to remote temperature sensor.
GND	5	Ground	Supply ground connection.
SCL	8	Digital input	Serial clock line for SMBus. Input; requires pullup resistor to voltage between 1.7 V and 3.6 V if driven by open-drain output.
SDA	7	Bidirectional digital input-output	Serial data line for SMBus. Open-drain; requires pullup resistor to voltage between 1.7 V and 3.6 V.
THERM	4	Digital output	Thermal shutdown or fan-control pin. Open-drain; requires pullup resistor to voltage between 1.7 V and 3.6 V.
V+	1	Power supply	Positive supply voltage, 1.7 V to 3.6 V.

6 Specifications

6.1 Absolute Maximum Ratings

Over operating free-air temperature range, unless otherwise noted.⁽¹⁾

		MIN	MAX	UNIT
Power supply	V+	–0.3	3.6	V
Input voltage	THERM, ALERT/THERM2, SDA and SCL only	–0.3	3.6	V
	D+ only	–0.3	(V+) + 0.3	V
	D– only	–0.3	0.3	V
Input current			10	mA
Operating temperature		–55	127	°C
Junction temperature (T _{Jmax})			150	°C
T _{stg}	Storage temperature	–60	150	°C

- (1) Stresses above these ratings may cause permanent damage. Exposure to absolute maximum conditions for extended periods may degrade device reliability. These are stress ratings only, and functional operation of the device at these or any other conditions beyond those specified is not implied.

6.2 ESD Ratings

			VALUE	UNIT
V _(ESD)	Electrostatic discharge	Human body model (HBM), per ANSI/ESDA/JEDEC JS-001, all pins ⁽¹⁾	±2000	V
		Charged device model (CDM), per JEDEC specification JESD22-C101, all pins ⁽²⁾	±750	

(1) JEDEC document JEP155 states that 500-V HBM allows safe manufacturing with a standard ESD control process.

(2) JEDEC document JEP157 states that 250-V CDM allows safe manufacturing with a standard ESD control process.

TMP451

SBOS686A – JUNE 2013 – REVISED DECEMBER 2014

www.ti.com

6.3 Recommended Operating Conditions

over operating free-air temperature range (unless otherwise noted)

	MIN	NOM	MAX	UNIT
Supply voltage	1.7	3.3	3.6	V
T _A Operating free-air temperature	-40		125	°C

6.4 Thermal Information

THERMAL METRIC ⁽¹⁾		TMP451	UNIT
		DQF	
		8 PINS	
R _{θJA}	Junction-to-ambient thermal resistance	171.3	°C/W
R _{θJC(top)}	Junction-to-case (top) thermal resistance	81.4	
R _{θJB}	Junction-to-board thermal resistance	137.9	
Ψ _{JT}	Junction-to-top characterization parameter	3.9	
Ψ _{JB}	Junction-to-board characterization parameter	140	

(1) For more information about traditional and new thermal metrics, see the *IC Package Thermal Metrics* application report, [SPRA953](#).

6.5 Electrical Characteristics

At T_A = -40°C to 125°C and V₊ = 3.3 V, unless otherwise noted.

PARAMETER		CONDITIONS	MIN	TYP	MAX	UNIT
TEMPERATURE ERROR						
T _{ELOCAL} Local temperature sensor	T _A = 0°C to 70°C			±0.25	±1	°C
	T _A = -40°C to 125°C			±1	±2	°C
T _{EREMOTE} Remote temperature sensor ⁽¹⁾	T _A = 0°C to 70°C, T _D = -55°C to 150°C			±0.25	±1	°C
	T _A = -40°C to 100°C, T _D = -55°C to 150°C			±1	±2	°C
	T _A = -40°C to 125°C, T _D = -55°C to 150°C			±2	±4	°C
Remote temperature sensor versus supply (local or remote)		V ₊ = 1.7 V to 3.6 V		±0.1	±0.25	°C/V
TEMPERATURE MEASUREMENT						
Conversion time		One-Shot mode, local and remote total		31	34	ms
Local temperature sensor resolution				12		Bits
Remote temperature sensor resolution				12		Bits
Remote sensor source current, high		Series resistance 1 kΩ max		120		μA
Remote sensor source current, medium				45		μA
Remote sensor source current, low				7.5		μA
η Remote transistor ideality factor		TMP451 optimized ideality factor		1.008		
SMBus INTERFACE						
V _{IH} High-level input voltage			1.4			V
V _{IL} Low-level input voltage					0.45	V
Hysteresis				200		mV
SMBus output low sink current			6			mA
V _{OL} Low-level output voltage		I _O = 6 mA		0.15	0.4	V
Logic input current		0 V ≤ V _I ≤ 3.6 V	-1		1	μA
SMBus input capacitance				3		pF
SMBus clock frequency			0.01		2.5	MHz
SMBus time-out			20	25	30	ms
SCL falling edge to SDA valid time					1	μs
DIGITAL OUTPUTS (THERM, ALERT/THERM2)						
V _{OL} Low-level output voltage		I _O = 6 mA		0.15	0.4	V
I _{OH} High-level output leakage current		V _O = V ₊			1	μA

(1) Tested with less than 5-Ω effective series resistance and 100-pF differential input capacitance.

Electrical Characteristics (continued)

At $T_A = -40^\circ\text{C}$ to 125°C and $V_+ = 3.3\text{ V}$, unless otherwise noted.

PARAMETER		CONDITIONS	MIN	TYP	MAX	UNIT
POWER SUPPLY						
$V_{(V+)}$	Specified voltage range		1.7		3.6	V
I_Q	Quiescent current	0.0625 conversions per second		27	40	μA
		16 conversions per second		165	250	μA
		32 conversions per second		300	450	μA
		Serial bus inactive, shutdown mode		3	8	μA
		Serial bus active, $f_S = 400\text{ kHz}$, shutdown mode		90		μA
		Serial bus active, $f_S = 2.5\text{ MHz}$, shutdown mode		350		μA
POR	Power-on reset threshold		1.2	1.55		V

6.6 Timing Requirements

PARAMETER		FAST MODE			HIGH-SPEED MODE			UNIT
		MIN	TYP	MAX	MIN	TYP	MAX	
$f_{(SCL)}$	SCL operating frequency	0.001		0.4	0.001		2.5	MHz
$t_{(BUF)}$	Bus free time between STOP and START Condition	1300			260			ns
$t_{(HDSTA)}$	Hold time after repeated START condition. After this period, the first clock is generated.	600			160			ns
$t_{(SUSTA)}$	Repeated START condition setup time	600			160			ns
$t_{(SUSTO)}$	STOP condition setup time	600			160			ns
$t_{(HDDAT)}$	Data hold time	0		900	0		150	ns
$t_{(SUDAT)}$	Data setup time	100			30			ns
$t_{(LOW)}$	SCL clock LOW period	1300			260			ns
$t_{(HIGH)}$	SCL clock HIGH period	600			60			ns
t_F, t_R – SDA	Data fall and rise time			300			80	ns
t_F, t_R – SCL	Clock fall and rise time			300			40	ns
t_R	Rise time for SCL $\leq 100\text{ kHz}$			1000				ns

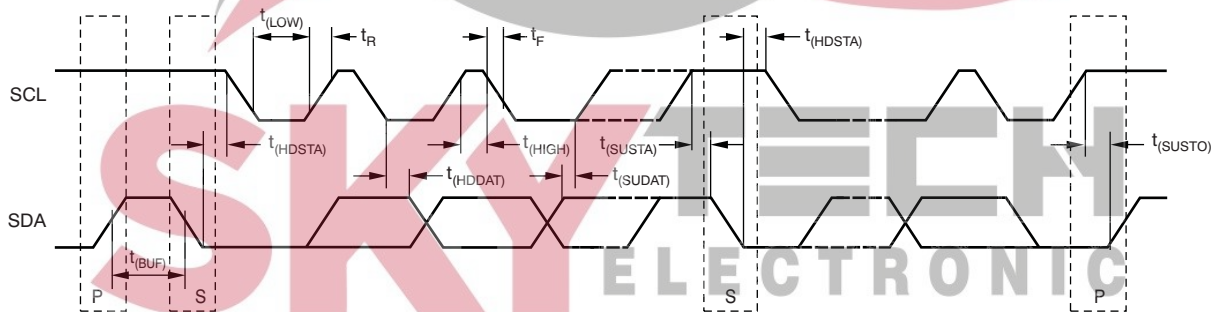

Figure 1. Two-Wire Timing Diagram

6.7 Typical Characteristics

At $T_A = 25^\circ\text{C}$ and $V_+ = 3.3\text{ V}$, unless otherwise noted.

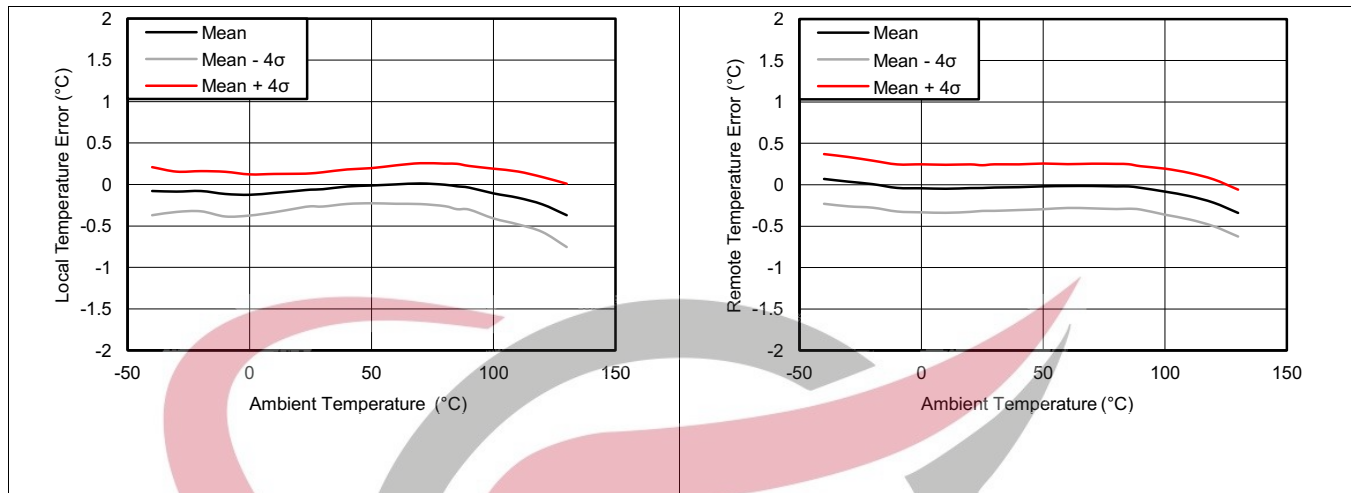

Figure 2. Local Temperature Error vs Temperature

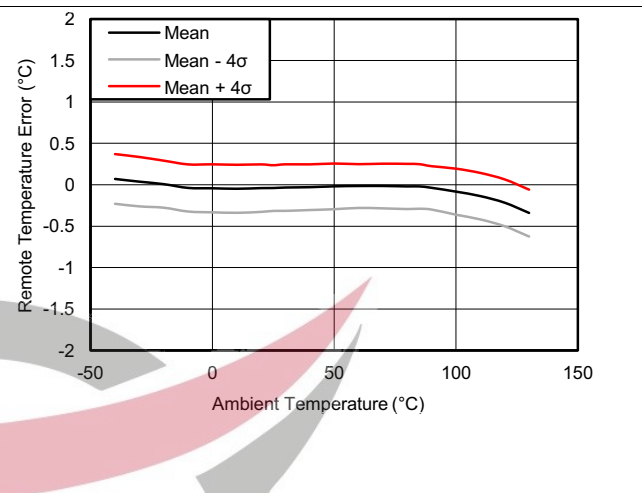

Figure 3. Remote Temperature Error vs Temperature

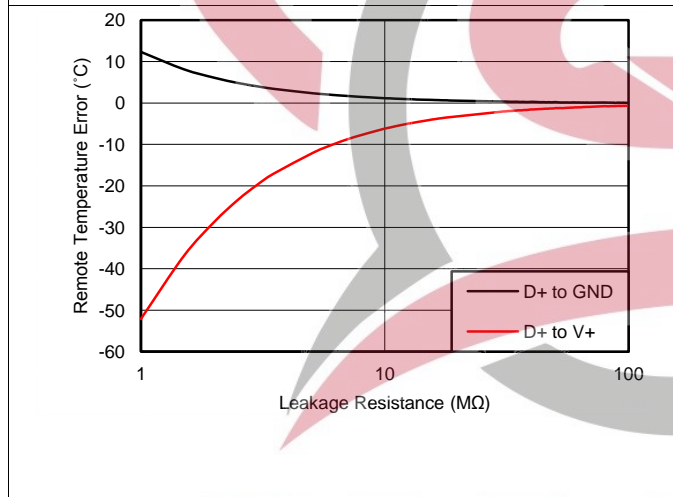

Figure 4. Remote Temperature Error vs Leakage Resistance

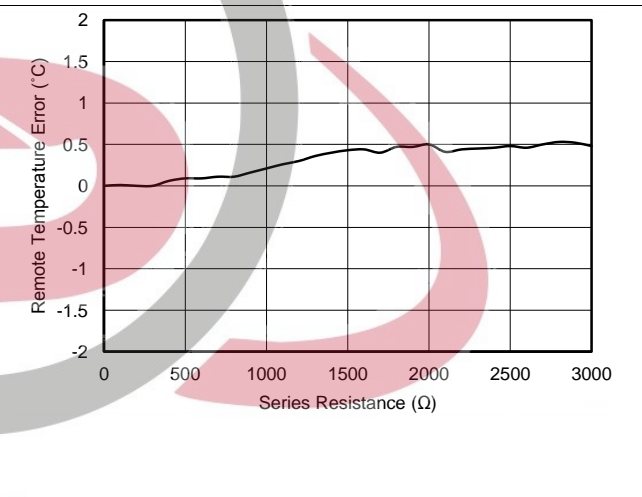

Figure 5. Remote Temperature Error vs Series Resistance

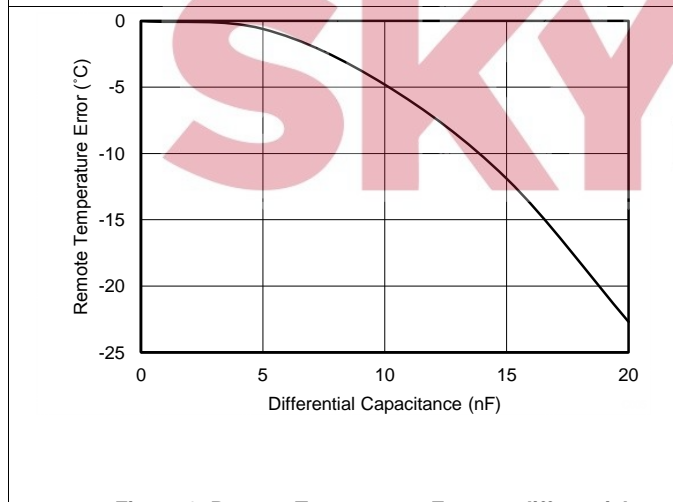

Figure 6. Remote Temperature Error vs differential Capacitance

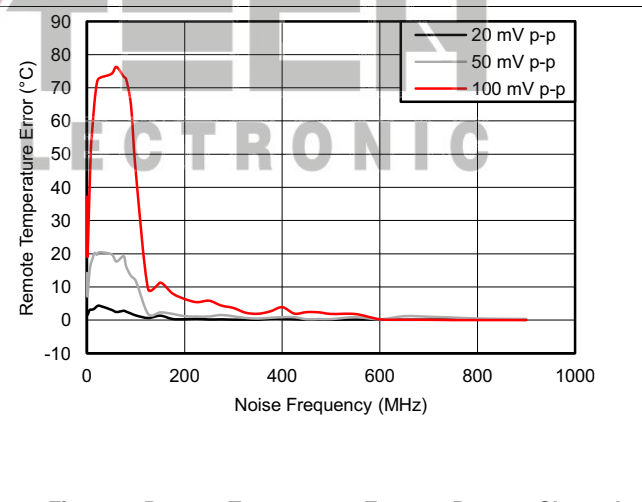

Figure 7. Remote Temperature Error vs Remote Channel Noise Frequency

Typical Characteristics (continued)

At $T_A = 25^\circ\text{C}$ and $V_+ = 3.3\text{ V}$, unless otherwise noted.

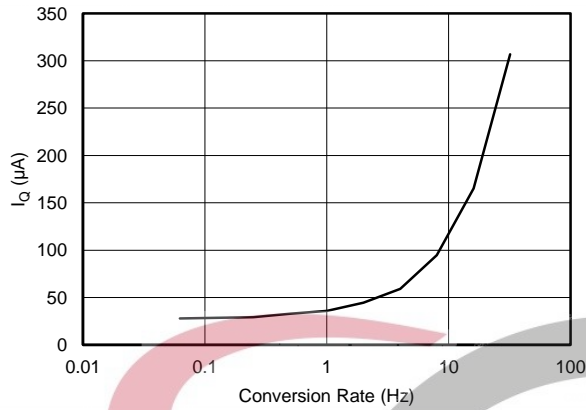

Figure 8. Quiescent Current vs Conversion Rate

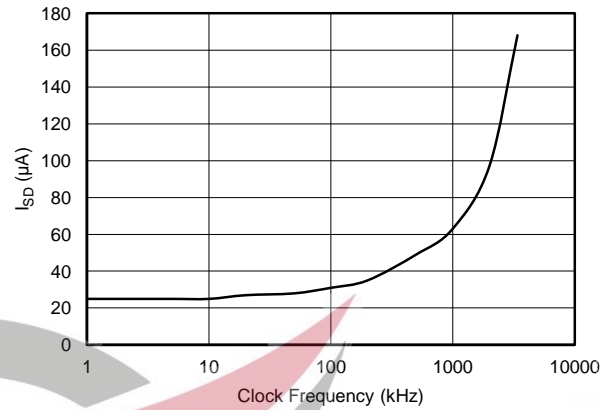

Figure 9. Shutdown Quiescent Current vs SCL Clock Frequency

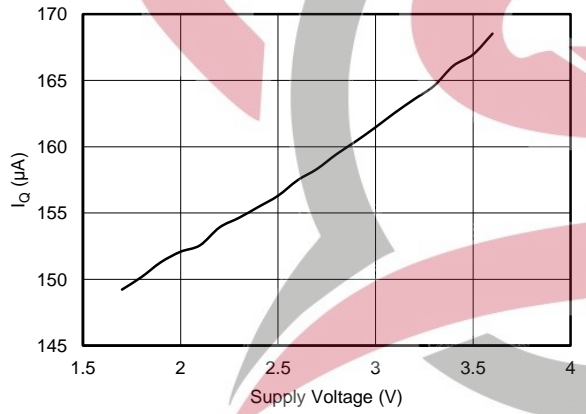

Figure 10. Quiescent Current vs Supply Voltage (At Default Conversion Rate of 16 Conversions per Second)

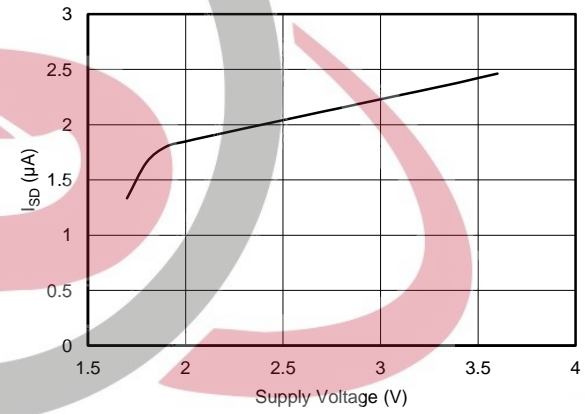
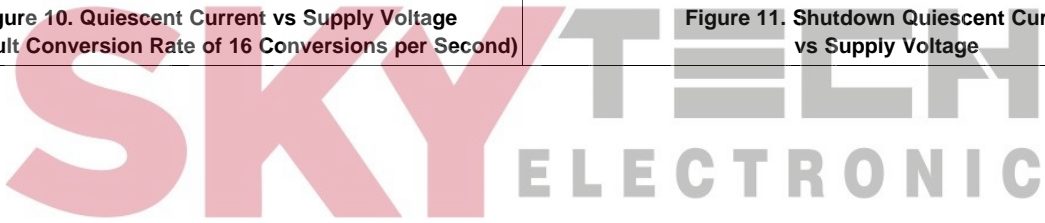

Figure 11. Shutdown Quiescent Current vs Supply Voltage



7 Detailed Description

7.1 Overview

The TMP451 device is a digital temperature sensor that combines a local temperature measurement channel and a remote-junction temperature measurement channel in a single DFN-8 package. The device is two-wire- and SMBus-interface compatible, and is specified over a temperature range of -40°C to 125°C . The TMP451 device also contains multiple registers for programming and holding configuration settings, temperature limits, and temperature measurement results.

7.2 Functional Block Diagram

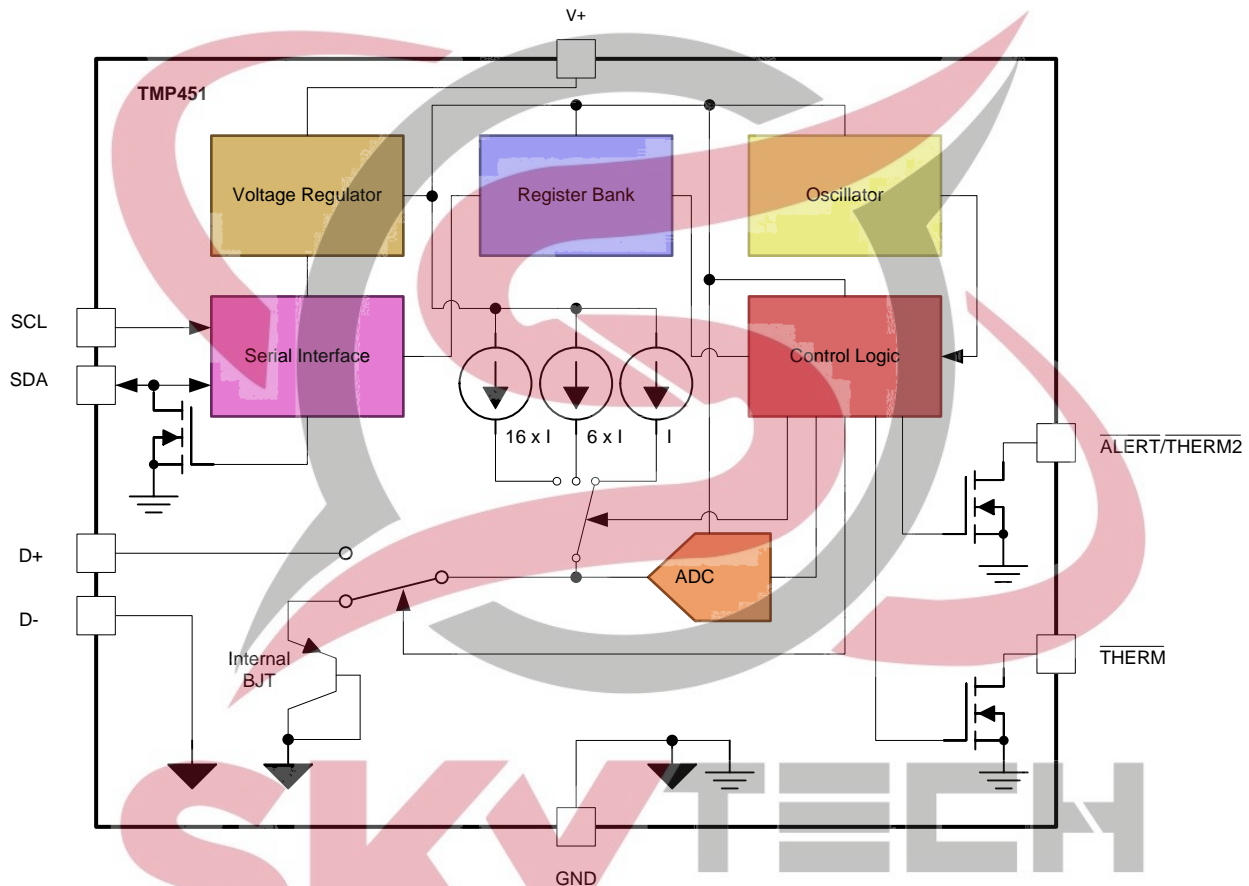

7.3 Feature Description

7.3.1 Temperature Measurement Data

The local and remote temperature sensors have a resolution of 12 bits (0.0625°C). Temperature data that result from conversions within the default measurement range are represented in binary form, as shown in the STANDARD BINARY column of [Table 1](#). Any temperature below 0°C results in a data value of 0 (00h). Likewise, temperatures above 127°C result in a value of 127 (7Fh). The device can be set to measure over an extended temperature range by changing bit 2 (RANGE) of configuration register from low to high. The change in measurement range and data format from standard binary to extended binary occurs at the next temperature conversion. For data captured in the extended temperature range configuration, an offset of 64 (40h) is added to the standard binary value, as shown in the EXTENDED BINARY column of [Table 1](#). This configuration allows measurement of temperatures as low as -64°C , and as high as 191°C ; however, most temperature-sensing diodes only measure with the range of -55°C to 150°C . Additionally, the TMP451 device is specified only for ambient temperatures ranging from -40°C to 125°C ; parameters in the [Absolute Maximum Ratings](#) table must be observed.

Feature Description (continued)
Table 1. Temperature Data Format (Local and Remote Temperature High Bytes)

TEMPERATURE (°C)	LOCAL AND REMOTE TEMPERATURE REGISTER HIGH BYTE VALUE (1°C RESOLUTION)			
	STANDARD BINARY ⁽¹⁾		EXTENDED BINARY ⁽²⁾	
	BINARY	HEX	BINARY	HEX
-64	0000 0000	00	0000 0000	00
-50	0000 0000	00	0000 1110	0E
-25	0000 0000	00	0010 0111	27
0	0000 0000	00	0100 0000	40
1	0000 0001	01	0100 0001	41
5	0000 0101	05	0100 0101	45
10	0000 1010	0A	0100 1010	4A
25	0001 1001	19	0101 1001	59
50	0011 0010	32	0111 0010	72
75	0100 1011	4B	1000 1011	8B
100	0110 0100	64	1010 0100	A4
125	0111 1101	7D	1011 1101	BD
127	0111 1111	7F	1011 1111	BF
150	0111 1111	7F	1101 0110	D6
175	0111 1111	7F	1110 1111	EF
191	0111 1111	7F	1111 1111	FF

(1) Resolution is 1°C/count. Negative values produce a read of 0°C.

(2) Resolution is 1°C/count. All values are unsigned with a -64°C offset.

Both local and remote temperature data use two bytes for data storage. The high byte stores the temperature with 1°C resolution. The second or low byte stores the decimal fraction value of the temperature and allows a higher measurement resolution, as shown in Table 2. The measurement resolution for both the local and the remote channels is 0.0625°C.

Table 2. Decimal Fraction Temperature Data Format (Local and Remote Temperature Low Bytes)

TEMP (°C)	TEMPERATURE REGISTER LOW BYTE VALUE (0.0625°C RESOLUTION) ⁽¹⁾	
	STANDARD AND EXTENDED BINARY	HEX
0	0000 0000	00
0.0625	0001 0000	10
0.1250	0010 0000	20
0.1875	0011 0000	30
0.2500	0100 0000	40
0.3125	0101 0000	50
0.3750	0110 0000	60
0.4375	0111 0000	70
0.5000	1000 0000	80
0.5625	1001 0000	90
0.6250	1010 0000	A0
0.6875	1011 0000	B0
0.7500	1100 0000	C0
0.8125	1101 0000	D0
0.8750	1110 0000	E0
0.9385	1111 0000	F0

(1) Resolution is 0.0625°C/count. All possible values are shown.

7.3.1.1 Standard Binary-to-Decimal Temperature Data Calculation Example

High-byte conversion (for example, 0111 0011):

Convert the right-justified binary high byte to hexadecimal.

From hexadecimal, multiply the first number by $16^0 = 1$ and the second number by $16^1 = 16$.

The sum equals the decimal equivalent.

$$0111\ 0011b \rightarrow 73h \rightarrow (3 \times 16^0) + (7 \times 16^1) = 115$$

Low-byte conversion (for example, 0111 0000):

To convert the left-justified binary low-byte to decimal, use bits 7 through 4 and ignore bits 3 through 0 because they do not affect the value of the number.

$$0111b \rightarrow (0 \times 1/2)^1 + (1 \times 1/2)^2 + (1 \times 1/2)^3 + (1 \times 1/2)^4 = 0.4375$$

7.3.1.2 Standard Decimal-to-Binary Temperature Data Calculation Example

For positive temperatures (for example, 20°C):

$$(20^\circ\text{C}) / (1^\circ\text{C}/\text{count}) = 20 \rightarrow 14h \rightarrow 0001\ 0100$$

Convert the number to binary code with 8-bit, right-justified format, and MSB = 0 to denote a positive sign.

20°C is stored as 0001 0100 → 14h.

For negative temperatures (for example, -20°C):

$$(|-20|) / (1^\circ\text{C}/\text{count}) = 20 \rightarrow 14h \rightarrow 0001\ 0100$$

Generate the two's complement of a negative number by complementing the absolute value binary number and adding 1.

-20°C is stored as 1110 1100 → ECh.

7.3.2 Series Resistance Cancellation

Series resistance cancellation automatically eliminates the temperature error caused by the resistance of the routing to the remote transistor or by the resistors of the optional external low-pass filter. A total of up to 1 kΩ of series resistance can be cancelled by the TMP451 device, eliminating the need for additional characterization and temperature offset correction. See [Figure 5](#) for details on the effects of series resistance on sensed remote temperature error.

7.3.3 Differential Input Capacitance

The TMP451 device tolerates differential input capacitance of up to 1000 pF with minimal change in temperature error. The effect of capacitance on sensed remote temperature error is shown in [Figure 6](#).

7.3.4 Filtering

Remote junction temperature sensors are usually implemented in a noisy environment. Noise is most often created by fast digital signals, and it can corrupt measurements. The TMP451 device has a built-in, 65-kHz filter on the inputs of D+ and D- to minimize the effects of noise. However, a bypass capacitor placed differentially across the inputs of the remote temperature sensor is recommended to make the application more robust against unwanted coupled signals. For this capacitor, select a value of between 100 pF and 1 nF. Some applications attain better overall accuracy with additional series resistance; however, this increased accuracy is application-specific. When series resistance is added, the total value should not be greater than 1 kΩ. If filtering is required, suggested component values are 100 pF and 50 Ω on each input; exact values are application-specific.

Additionally, a digital filter is available for the remote temperature measurements to further reduce the effect of noise. This filter is programmable and has two levels when enabled. Level 1 performs a moving average of four consecutive samples. Level 2 performs a moving average of eight consecutive samples. The value stored in the remote temperature result register is the output of the digital filter, and the ALERT and THERM limits are compared to it. This provides additional immunity to noise and spikes on the ALERT and THERM outputs. The filter responses are shown in Figure 12. The filter can be enabled or disabled by programming the desired levels in the digital filter register. The digital filter is disabled by default and on POR.

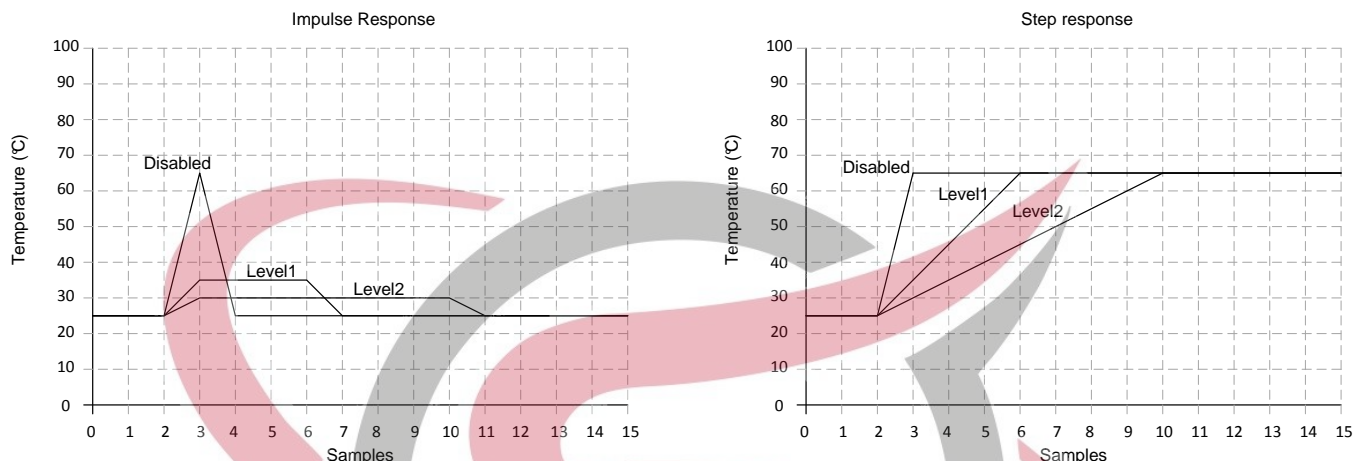

Figure 12. Filter Response to Impulse and Step Inputs

7.3.5 Sensor Fault

The TMP451 device can sense a fault at the D+ input resulting from incorrect diode connection. The TMP451 device can also sense an open circuit. Short-circuit conditions return a value of -64°C . The detection circuitry consists of a voltage comparator that trips when the voltage at D+ exceeds $(V+) - 0.3\text{ V}$ (typical). The comparator output is continuously checked during a conversion. If a fault is detected, then OPEN (bit 2) in the status register is set to 1.

When not using the remote sensor with the TMP451 device, the D+ and D- inputs must be connected together to prevent meaningless fault warnings.



7.3.6 ALERT and THERM Functions

The operation of the $\overline{\text{ALERT}}$ (pin 6) and $\overline{\text{THERM}}$ (pin 4) interrupts is shown in Figure 13. The operation of the THERM (pin 4) and THERM2 (pin 6) interrupts is shown in Figure 14.

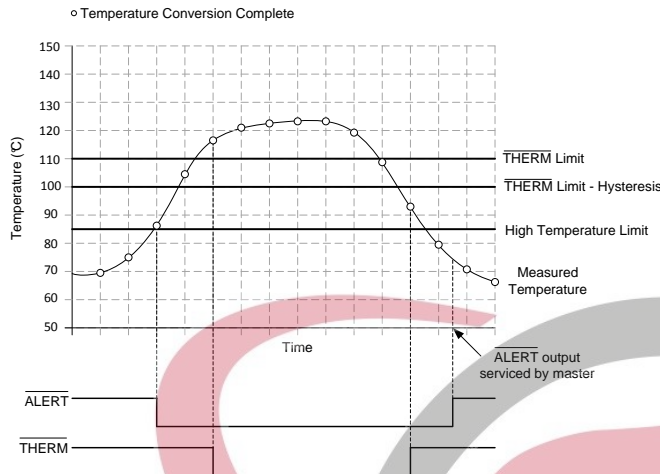

Figure 13. $\overline{\text{ALERT}}$ and $\overline{\text{THERM}}$ Interrupt Operation

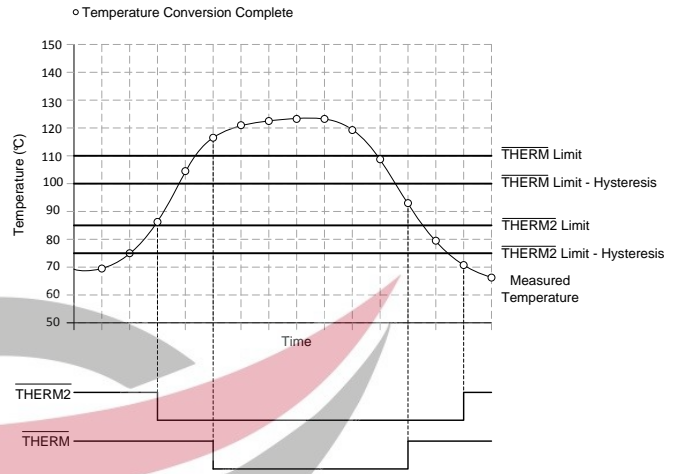

Figure 14. $\overline{\text{THERM}}$ and $\overline{\text{THERM2}}$ Interrupt Operation

The hysteresis value is stored in the $\overline{\text{THERM}}$ hysteresis register. The value of the $\text{CONAL}[2:0]$ bits in the consecutive $\overline{\text{ALERT}}$ register determines the number of limit violations before the $\overline{\text{ALERT}}$ pin is tripped. The default value is 000b and corresponds to one violation, 001b programs two consecutive violations, 011b programs three consecutive violations, and 111b programs four consecutive violations. This provides additional filtering for the $\overline{\text{ALERT}}$ pin state.

7.4 Device Functional Modes

7.4.1 Shutdown Mode (SD)

The TMP451 shutdown mode enables the user to save maximum power by shutting down all device circuitry other than the serial interface, reducing current consumption to typically less than 3 μA ; see Figure 11. Shutdown mode is enabled when the SD bit (bit 6) of the configuration register is high; the device shuts down after the current conversion is finished. When the SD bit is low, the device maintains a continuous-conversion state.

7.4.2 One-shot Mode

When the TMP451 device is in shutdown mode ($\text{SD} = 1$ in the configuration register), a single conversion is started by writing any value to the one-shot start register, pointer address 0Fh. This write operation starts one conversion and comparison cycle on both the local and the remote sensors. The TMP451 device returns to shutdown mode when the cycle completes. The value of the data sent in the write command is irrelevant and is not stored by the TMP451 device.

7.5 Programming

7.5.1 Serial Interface

The TMP451 device operates only as a slave device on either the two-wire bus or the SMBus. Connections to either bus are made using the open-drain I/O lines, SDA and SCL. The SDA and SCL pins feature integrated spike suppression filters and Schmitt triggers to minimize the effects of input spikes and bus noise. The TMP451 device supports the transmission protocol for fast (1 kHz to 400 kHz) and high-speed (1 kHz to 2.5 MHz) modes. All data bytes are transmitted MSB first.

Programming (continued)

7.5.1.1 Bus Overview

The TMP451 device is SMBus interface compatible. In SMBus protocol, the device that initiates the transfer is called a master, and the devices controlled by the master are slaves. The bus must be controlled by a master device that generates the serial clock (SCL), controls the bus access, and generates the START and STOP conditions.

To address a specific device, a START condition is initiated. A START condition is indicated by pulling the data line (SDA) from a high-to-low logic level while SCL is high. All slaves on the bus shift in the slave address byte, with the last bit indicating whether a read or write operation is intended. During the ninth clock pulse, the slave being addressed responds to the master by generating an acknowledge bit and pulling SDA low.

Data transfer is then initiated and sent over eight clock pulses followed by an acknowledge bit. During data transfer SDA must remain stable while SCL is high, because any change in SDA while SCL is high is interpreted as a control signal.

After all data have been transferred, the master generates a STOP condition. A STOP condition is indicated by pulling SDA from low to high, while SCL is high.

7.5.1.2 Bus Definitions

The TMP451 device is two-wire and SMBus-compatible. Figure 15 and Figure 16 show the timing for various operations on the TMP451 device. The bus definitions are as follows:

Acknowledge: Each receiving device, when addressed, is obliged to generate an acknowledge bit. A device that acknowledges must pull down the SDA line during the acknowledge clock pulse in such a way that the SDA line is stable low during the high period of the acknowledge clock pulse. Take setup and hold times into account. On a master receive, data transfer termination can be signaled by the master generating a not-acknowledge on the last byte that has been transmitted by the slave.

Bus Idle: Both SDA and SCL lines remain high.

Data Transfer: The number of data bytes transferred between a START and a STOP condition is not limited and is determined by the master device. The receiver acknowledges data transfer.

Start Data Transfer: A change in the state of the SDA line, from high to low, while the SCL line is high, defines a start condition. Each data transfer initiates with a START condition.

Stop Data Transfer: A change in the state of the SDA line from low to high while the SCL line is high defines a STOP condition. Each data transfer terminates with a repeated START or STOP condition.

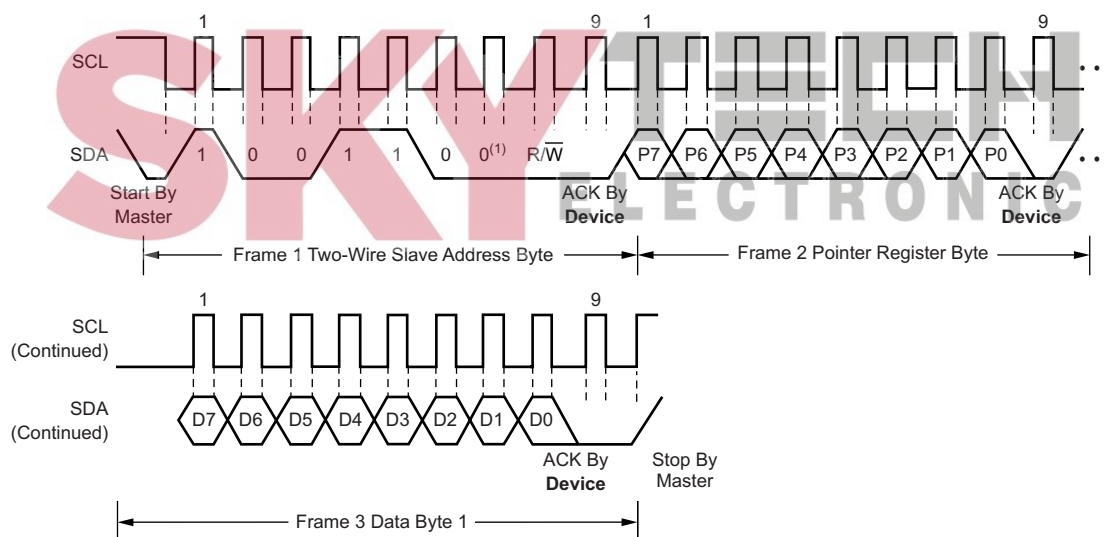

(1) Slave address 1001100 shown.

Figure 15. Two-Wire Timing Diagram for Write Word Format

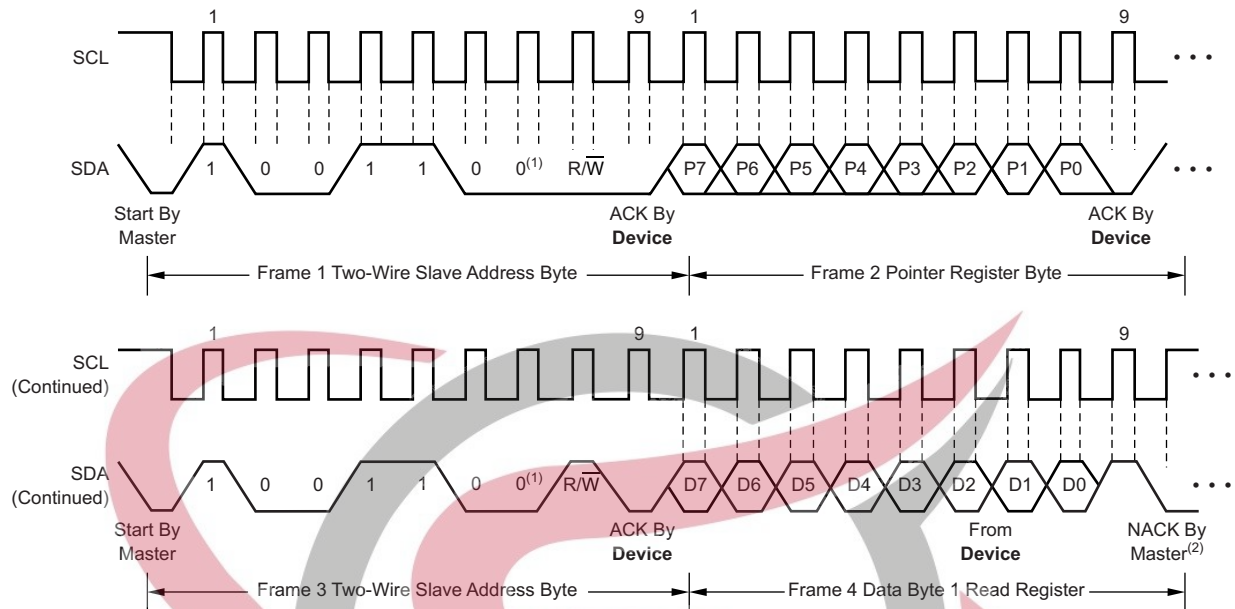
Programming (continued)

(1) Slave address 1001100 shown.

(2) Master should leave SDA high to terminate a single-byte read operation.

Figure 16. Two-Wire Timing Diagram for Single-Byte Read Format

7.5.1.3 Serial Bus Address

To communicate with the TMP451 device, the master must first address slave devices using a slave address byte. The slave address byte consists of seven address bits, and a direction bit indicating the intent of executing a read or write operation. The TMP451 device has a device address of 4Ch (1001 100b). Additional factory-programmed device addresses are available upon request.

7.5.1.4 Read and Write Operations

Accessing a particular register on the TMP451 device is accomplished by writing the appropriate value to the pointer register. The value for the pointer register is the first byte transferred after the slave address byte with the R/W bit low. Every write operation to the TMP451 device requires a value for the pointer register (see Figure 15).

When reading from the TMP451 device the last value stored in the pointer register by a write operation is used to determine which register is read by a read operation. To change which register is read for a read operation, a new value must be written to the pointer register. This transaction is accomplished by issuing a slave address byte with the R/W bit low, followed by the pointer register byte; no additional data are required. The master can then generate a START condition and send the slave address byte with the R/W bit high to initiate the read command; see Figure 16 for details of this sequence.

If repeated reads from the same register are desired, it is not necessary to continually send the pointer register bytes, because the TMP451 device retains the pointer register value until it is changed by the next write operation. The register bytes are sent MSB first, followed by the LSB.

Read operations should be terminated by issuing a *not-acknowledge* command at the end of the last byte to be read. For single-byte operation, the master must leave the SDA line high during the acknowledge time of the first byte that is read from the slave.

Programming (continued)

7.5.1.5 Time-out Function

If the SMBus time-out function is enabled, the TMP451 device resets the serial interface if either SCL or SDA are held low for 25 ms (typical) between a START and STOP condition. If the TMP451 device is holding the bus low, the device releases the bus and waits for a START condition. To avoid activating the time-out function, maintaining a communication speed of at least 1 kHz for the SCL operating frequency is necessary. The SMBTO bit (bit 7) of the consecutive ALERT register controls the time-out enable. Setting the SMBTO bit to a value of 0 (default) disables the time-out. Setting the SMBTO bit to a value of 1 enables the function.

7.5.1.6 High-speed Mode

For the two-wire bus to operate at frequencies above 1 MHz, the master device must issue a high-speed mode (Hs-mode) master code (0000 1xxx) as the first byte after a START condition to switch the bus to high-speed operation. The TMP451 device does not acknowledge this byte, but switches the input filters on SDA and SCL and the output filter on SDA to operate in Hs-mode, allowing transfers at up to 2.5 MHz. After the Hs-mode master code has been issued, the master transmits a two-wire slave address to initiate a data transfer operation. The bus continues to operate in Hs-mode until a STOP condition occurs on the bus. Upon receiving the STOP condition, the TMP451 device switches the input and output filters back to fast mode operation.

7.5.1.7 General Call Reset

The TMP451 device supports reset using the two-wire general call address 00h (0000 0000b). The TMP451 device acknowledges the general call address and responds to the second byte. If the second byte is 06h (0000 0110b), the TMP451 device executes a software reset. This software reset restores the power-on reset state to all TMP451 registers, and it aborts any conversion in progress. The TMP451 device takes no action in response to other values in the second byte.



7.6 Register Map

Table 3. Register Map

POINTER READ (HEX)	POINTER WRITE (HEX)	POR (HEX)	BIT DESCRIPTION								REGISTER DESCRIPTION
			7	6	5	4	3	2	1	0	
00	N/A	00	LT11	LT10	LT9	LT8	LT7	LT6	LT5	LT4	Local temperature (high byte)
01	N/A	00	RT11	RT10	RT9	RT8	RT7	RT6	RT5	RT4	Remote temperature (high byte)
02	N/A	N/A	BUSY	LHIGH	LLOW	RHIGH	RLOW	OPEN	RTHRM	LTHRM	Status register
03	09	00	MASK1	SD	ALERT/ THERM2	0	0	RANGE	0	0	Configuration register
04	0A	08	0	0	0	0	CR3	CR2	CR1	CR0	Conversion rate register
05	0B	55	LTHL11	LTHL10	LTHL9	LTHL8	LTHL7	LTHL6	LTHL5	LTHL4	Local temperature high limit
06	0C	00	LTL11	LTL10	LTL9	LTL8	LTL7	LTL6	LTL5	LTL4	Local temperature low limit
07	0D	55	RTHL11	RTHL10	RTHL9	RTHL8	RTHL7	RTHL6	RTHL5	RTHL4	Remote temperature high limit (high byte)
08	0E	00	RTL11	RTL10	RTL9	RTL8	RTL7	RTL6	RTL5	RTL4	Remote temperature low limit (high byte)
N/A	0F	N/A	X	X	X	X	X	X	X	X	One-shot start Table 14
10	N/A	00	RT3	RT2	RT1	RT0	0	0	0	0	Remote temperature (low byte)
11	11	00	RTOS11	RTOS10	RTOS9	RTOS8	RTOS7	RTOS6	RTOS5	RTOS4	Remote temperature offset (high byte)
12	12	00	RTOS3	RTOS2	RTOS1	RTOS0	0	0	0	0	Remote temperature offset (low byte)
13	13	00	RTHL3	RTHL2	RTHL1	RTHL0	0	0	0	0	Remote temperature high limit (low byte)
14	14	00	RTL3	RTL2	RTL1	RTL0	0	0	0	0	Remote temperature low limit (low byte)
15	N/A	00	LT3	LT2	LT1	LT0	0	0	0	0	Local temperature (low byte)
19	19	6C	RTH11	RTH10	RTH9	RTH8	RTH7	RTH6	RTH5	RTH4	Remote temperature THERM limit
20	20	55	LTH11	LTH10	LTH9	LTH8	LTH7	LTH6	LTH5	LTH4	Local temperature THERM limit
21	21	0A	HYS11	HYS10	HYS9	HYS8	HYS7	HYS6	HYS5	HYS4	THERM hysteresis
22	22	01	SMBTO	0	0	0	CONAL2	CONAL1	CONAL0	1	Consecutive ALERT
23	23	00	NC7	NC6	NC5	NC4	NC3	NC2	NC1	NC0	η -factor correction
24	24	00	0	0	0	0	0	0	DF1	DF0	Digital filter control
FE	N/A	55	0	1	0	1	0	1	0	1	Manufacturer ID

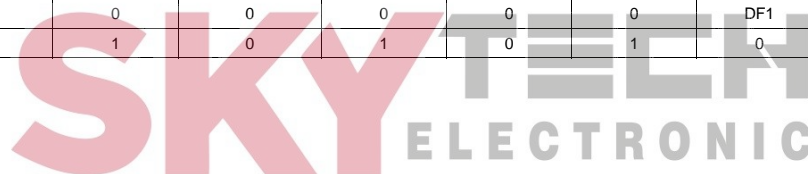

7.6.1 Register Information

The TMP451 device contains multiple registers for holding configuration information, temperature measurement results, and status information. These registers are described in [Figure 17](#) and [Table 3](#).

7.6.1.1 Pointer Register

[Figure 17](#) shows the internal register structure of the TMP451 device. The 8-bit pointer register is used to address a given data register. The pointer register identifies which of the data registers should respond to a read or write command on the two-wire bus. This register is set with every write command. A write command must be issued to set the proper value in the pointer register before executing a read command. [Table 3](#) describes the pointer register and the internal structure of the TMP451 registers. The power-on reset (POR) value of the pointer register is 00h (0000 0000b).

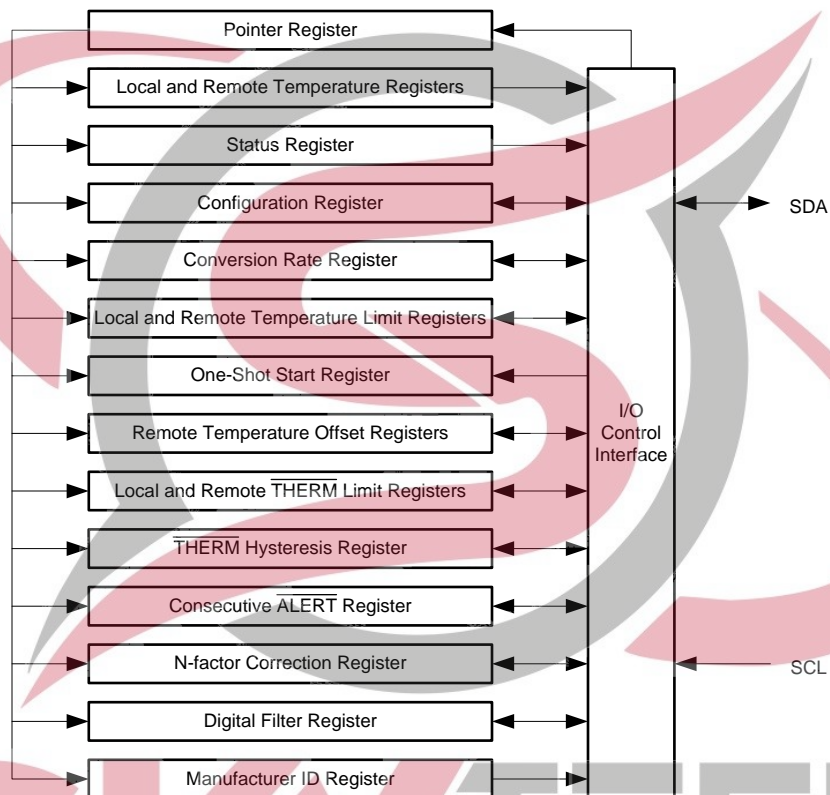

Figure 17. Internal Register Structure

7.6.1.2 Temperature Registers

The TMP451 device has multiple 8-bit registers that hold temperature measurement results. The eight most significant bits (MSBs) of the local temperature sensor result are stored in register 00h, while the four least significant bits (LSBs) are stored in register 15h (the four MSBs of register 15h). The eight MSBs of the remote temperature sensor result are stored in register 01h, and the four LSBs are stored in register 10h (the four MSBs of register 10h). The four LSBs of both the local sensor and the remote sensor indicate the temperature value after the decimal point (for example, if the temperature result is 10.0625°C, the high byte is 0000 1010 and the low byte is 0001 0000). These registers are read-only and are updated by the ADC each time a temperature measurement.

When the full temperature value is needed, reading the MSB value first causes the LSB value to be locked (the ADC does not write to it) until it is read. The same thing happens upon reading the LSB value first (the MSB value is locked until it is read). This mechanism assures that both bytes of the read operation are from the same ADC conversion. This assurance remains valid only until another register is read. For proper operation, read the high byte of the temperature result first. Read the low byte register in the next read command; if the LSBs are not needed, the register may be left unread. The power-on reset value of all temperature registers is 00h.

7.6.1.3 Local Temperature High Byte Register (offset: Read = 00h; Write = N/A) [reset = 00h]

Figure 18. Local Temperature High Byte Register

7	6	5	4	3	2	1	0
LT11	LT10	LT9	LT8	LT7	LT6	LT5	LT4
R-0	R-0	R-0	R-0	R-0	R-0	R-0	R-0

LEGEND: R/W = Read/Write; R = Read only; -n = value after reset

Table 4. Local Temperature High Byte Register Field Descriptions

Bit	Field	Type	Reset	Description
7 - 0	LT11 - LT4	R	0h	Local temperature high byte. The resolution of the LSB in this register is 1°C. This register is read-only and is updated by the ADC each time a temperature measurement is completed. When the full temperature value is needed, reading the high byte register first causes the low byte register value to be locked (the ADC does not write to it) until it is read. The same thing happens upon reading the low byte register value first (the high byte register value is locked until it is read). This mechanism assures that both bytes of the read operation are from the same ADC conversion. This assurance remains valid only until another register is read. For proper operation, read the high byte of the temperature result first. Read the low byte register in the next read command; if the low byte is not needed, the register may be left unread.

7.6.1.4 Remote Temperature High Byte Register (offset: Read = 01h; Write = N/A) [reset = 00h]

Figure 19. Remote Temperature High Byte Register

7	6	5	4	3	2	1	0
RT11	RT10	RT9	RT8	RT7	RT6	RT5	RT4
R-0h	R-0h	R-0h	R-0h	R-0h	R-0h	R-0h	R-0h

LEGEND: R/W = Read/Write; R = Read only; -n = value after reset

Table 5. Remote Temperature High Byte Register Field Descriptions

Bit	Field	Type	Reset	Description
7 - 0	RT11 - RT4	R	0h	Remote temperature high byte. The resolution of the LSB in this register is 1 °C. This register is read-only and is updated by the ADC each time a temperature measurement is completed. When the full temperature value is needed, reading the high byte register first causes the low byte register value to be locked (the ADC does not write to it) until it is read. The same thing happens upon reading the low byte register value first (the high byte register value is locked until it is read). This mechanism assures that both bytes of the read operation are from the same ADC conversion. This assurance remains valid only until another register is read. For proper operation, read the high byte of the temperature result first. Read the low byte register in the next read command; if the low byte is not needed, the register may be left unread.

7.6.1.5 Status Register (offset: Read = 02h; Write = N/A) [reset = N/A]

Figure 20. Status Register

7	6	5	4	3	2	1	0
BUSY	LHIGH	LLOW	RHIGH	RLOW	OPEN	RTHRM	LTHRM
R	R	R	R	R	R	R	R

LEGEND: R/W = Read/Write; R = Read only; -n = value after reset

Table 6. Status Register Field Descriptions

Bit	Field	Type	Reset	Description
7	BUSY	R	N/A	ADC status indicator 1 = ADC is converting. 0 = ADC is not converting.
6	LHIGH	R	N/A	Local temperature high limit status indicator ⁽¹⁾ 1 = Local temperature value exceeds the Local Temperature High Limit Register value. This bit is cleared upon reading the Status Register providing that the condition causing the over temperature result is no longer present. 0 = Local temperature value does not exceed the Local Temperature High Limit Register value.
5	LLOW	R	N/A	Local temperature low limit status indicator ⁽¹⁾ 1 = Local temperature value is below the Local Temperature Low Limit Register value. This bit is cleared upon reading the Status Register providing that the condition causing the under temperature result is no longer present. 0 = Local temperature value is not below the Local Temperature Low Limit Register value.
4	RHIGH	R	N/A	Remote temperature high limit status indicator ⁽¹⁾ 1 = Remote temperature value exceeds the Remote Temperature High Limit Register value. This bit is cleared upon reading the Status Register providing that the condition causing the over temperature result is no longer present. 0 = Remote temperature value does not exceed the Remote Temperature High Limit Register value.
3	RLOW	R	N/A	Remote temperature low limit status indicator ⁽¹⁾ 1 = Remote temperature value is below the Remote Temperature Low Limit Register value. This bit is cleared upon reading the Status Register providing that the condition causing the under temperature result is no longer present. 0 = Remote temperature value is not below the Remote Temperature Low Limit Register value.
2	OPEN	R	N/A	Remote junction open circuit detection ⁽¹⁾ 1 = The remote junction is an open circuit. This bit is cleared upon reading the Status Register providing that the condition causing the open circuit is no longer present. 0 = The remote junction is not an open circuit.
1	RTHRM	R	N/A	Remote THERM limit status indicator 1 = Remote THERM limit is tripped. This bit is cleared upon reading the Status Register providing that the condition causing the over temperature result is no longer present. 0 = Remote THERM limit is not tripped.
0	LTHRM	R	N/A	Local THERM limit status indicator 1 = Local THERM limit is tripped. This bit is cleared upon reading the Status Register providing that the condition causing the over temperature result is no longer present. 0 = Local THERM limit is not tripped.

(1) These flags stay high until the status register is read or they are reset by a POR when pin 6 is configured as ALERT. Only bit 2 (OPEN) stays high until the status register is read or it is reset by a POR when pin 6 is configured as THERM2.

The status register reports the state of the temperature ADC, the temperature limit comparators, and the connection to the remote sensor. Table 6 lists the status register bits. The status register is read-only, and is read by accessing pointer address 02h.

The LHIGH and LLOW bits indicate a local sensor overtemperature or undertemperature event, respectively. The RHIGH and RLOW bits indicate a remote sensor overtemperature or undertemperature event, respectively. The OPEN bit indicates an open-circuit condition on the remote sensor. When pin 6 is configured as the ALERT output, the five flags are NORed together. If any of the five flags are high, the ALERT interrupt latch is set and the ALERT output goes low. Reading the status register clears the five flags, provided that the condition that

caused the setting of the flags is not present anymore (that is, the value of the corresponding result register is within the limits, or the remote sensor is connected properly and functional). The $\overline{\text{ALERT}}$ interrupt latch (and the $\overline{\text{ALERT}}$ pin correspondingly) is not reset by reading the status register. The reset is done by the master reading the temperature sensor device address to service the interrupt, and only if the flags have been reset and the condition that caused them to be set is not present.

The RTHRM and LTHRM flags are set when the corresponding temperature exceeds the programmed $\overline{\text{THERM}}$ limit. They are reset automatically when the temperature returns to within the limits. The $\overline{\text{THERM}}$ output goes low in the case of overtemperature on either the local or the remote channel, and goes high as soon as the measurements are within the limits again. The $\overline{\text{THERM}}$ hysteresis register (21h) allows hysteresis to be added so that the flag resets and the output goes high when the temperature returns to or goes below the limit value minus the hysteresis value.

When pin 6 is configured as $\overline{\text{THERM2}}$, only the high limits matter. The LHIGH and RHIGH flags are set if the respective temperatures exceed the limit values, and the pin goes low to indicate the event. The LLOW and RLOW flags have no effect on $\overline{\text{THERM2}}$, and the output behaves the same way when configured as $\overline{\text{THERM}}$.

7.6.1.6 Configuration Register (offset: Read = 03h; Write = 09h) [reset = 00h]

Figure 21. Configuration Register

7	6	5	4	3	2	1	0
MASK1	SD	ALERT/THERM2	RESERVED		RANGE	RESERVED	
R/W-0h	R/W-0h	R/W-0h	R/W-0h		R/W-0h	R/W-0h	

LEGEND: R/W = Read/Write; R = Read only; -n = value after reset

Table 7. Configuration Register Field Descriptions

Bit	Field	Type	Reset	Description
7	MASK1	R/W	0h	This bit masks the $\overline{\text{ALERT}}$ output 1 = $\overline{\text{ALERT}}$ is disabled. 0 = $\overline{\text{ALERT}}$ is enabled.
6	SD	R/W	0h	Device shutdown control 1 = Places the device in shutdown mode. 0 = Places the device in continuous conversion mode.
5	ALERT/THERM2	R/W	0h	$\overline{\text{ALERT}}$ or $\overline{\text{THERM2}}$ mode select 1 = $\overline{\text{THERM2}}$ mode 0 = $\overline{\text{ALERT}}$ mode
2	RANGE	R/W	0h	This bit configures the range of the temperature measurement 1 = -64 °C to 191 °C 0 = 0 °C to 127 °C

MASK1 of the configuration register masks the $\overline{\text{ALERT}}$ output. If MASK1 is 0 (default), the $\overline{\text{ALERT}}$ output is enabled. If MASK1 is set to 1, the $\overline{\text{ALERT}}$ output is disabled. This configuration applies only if the value of ALERT/THERM2 bit is 0 (that is, pin 6 is configured as the $\overline{\text{ALERT}}$ output). If pin 6 is configured as the $\overline{\text{THERM2}}$ output, the value of the MASK1 bit has no effect.

The shutdown bit, SD, enables or disables the temperature-measurement circuitry. If SD = 0 (default), the TMP451 device converts continuously at the rate set in the conversion rate register. When SD is set to 1, the TMP451 device stops converting when the current conversion sequence is complete and enters a shutdown mode. When SD is set to 0 again, the TMP451 resumes continuous conversions. When SD = 1, a single conversion can be started by writing to the one-shot start register. See the [One-shot Mode](#) section for more information.

$\overline{\text{ALERT/THERM2}}$ (bit 5) sets the configuration of pin 6. If the $\overline{\text{ALERT/THERM2}}$ bit is 0 (default), then pin 6 is configured as the $\overline{\text{ALERT}}$ output; if it is set to 1, then pin 6 is configured as the $\overline{\text{THERM2}}$ output.

The temperature range is set by configuring RANGE (bit 2) of the configuration register. Setting this bit low (default) configures the TMP451 device for the standard measurement range (0°C to 127°C); temperature conversions are stored in the standard binary format. Setting bit 2 high configures the TMP451 device for the extended measurement range (-64°C to 191°C); temperature conversions are stored in the extended binary format (see [Table 1](#)).

The remaining bits of the configuration register are reserved and must always be set to 0. The power-on reset value for this register is 00h.

7.6.1.7 Conversion Rate Register (offset: Read = 04h; Write = 0Ah) [reset = 08h]

Figure 22. Conversion Rate Register

7	6	5	4	3	2	1	0
RESERVED			CR3	CR2	CR1	CR0	
R/W-0h			R/W-1h	R/W-0h	R/W-0h	R/W-0h	

LEGEND: R/W = Read/Write; R = Read only; -n = value after reset

Table 8. Conversion Rate Register Field Descriptions

Bit	Field	Type	Reset	Description
3 - 0	CR3 - CR0	R/W	8h	Conversion rate selection. Refer to Table 9

The conversion rate register (read address 04h, write address 0Ah) controls the rate at which temperature conversions are performed. This register adjusts the idle time between conversions but not the conversion time itself, thereby allowing the TMP451 power dissipation to be balanced with the temperature register update rate. [Table 9](#) lists the conversion rate options and corresponding time between conversions. The default value of the register is 08h, which gives a default rate of 16 conversions per second.

Table 9. Conversion Rate

VALUE	CONVERSIONS PER SECOND	TIME (SECONDS)
00h	0.0625	16
01h	0.125	8
02h	0.25	4
03h	0.5	2
04h	1	1
05h	2	0.5
06h	4	0.25
07h	8	0.125
08h	16 (default)	0.0625 (default)
09h	32	0.03125

7.6.1.8 Local Temperature High Limit Register (offset: Read = 05h; Write = 0Bh) [reset = 55h]

Figure 23. Local Temperature High Limit Register

7	6	5	4	3	2	1	0
LTHL11	LTHL10	LTHL9	LTHL8	LTHL7	LTHL6	LTHL5	LTHL4
R/W-0h	R/W-1h	R/W-0h	R/W-1h	R/W-0h	R/W-1h	R/W-0h	R/W-1h

LEGEND: R/W = Read/Write; R = Read only; -n = value after reset

Table 10. Local Temperature High Limit Register Field Descriptions

Bit	Field	Type	Reset	Description
7 - 0	LTHL11 - LTHL4	R/W	55h	These bits determine the value of the high temperature limit to which the local temperature measurement is compared. The resolution of the LSB in this register is 1°C.

7.6.1.9 Local Temperature Low Limit Register (offset: Read = 06h; Write = 0Ch) [reset = 00h]
Figure 24. Local Temperature Low Limit Register

7	6	5	4	3	2	1	0
LTLL11	LTLL10	LTLL9	LTLL8	LTLL7	LTLL6	LTLL5	LTLL4
R/W-0h	R/W-0h	R/W-0h	R/W-0h	R/W-0h	R/W-0h	R/W-0h	R/W-0h

LEGEND: R/W = Read/Write; R = Read only; -n = value after reset

Table 11. Local Temperature Low Limit Register Field Descriptions

Bit	Field	Type	Reset	Description
7 - 0	LTLL11 - LTLL4	R/W	00h	These bits determine the value of the low temperature limit to which the local temperature measurement is compared. The resolution of the LSB in this register is 1°C.

7.6.1.10 Remote Temperature High Limit High Byte Register (offset: Read = 07h; Write = 0Dh) [reset = 55h]
Figure 25. Remote Temperature High Limit High Byte Register

7	6	5	4	3	2	1	0
RTHL11	RTHL10	RTHL9	RTHL8	RTHL7	RTHL6	RTHL5	RTHL4
R/W-0h	R/W-1h	R/W-0h	R/W-1h	R/W-0h	R/W-1h	R/W-0h	R/W-1h

LEGEND: R/W = Read/Write; R = Read only; -n = value after reset

Table 12. Remote Temperature High Limit High Byte Register Field Descriptions

Bit	Field	Type	Reset	Description
7 - 0	RTHL11 - RTHL4	R/W	55h	These bits determine the value of the high byte of the high temperature limit to which the remote temperature measurement is compared. The resolution of the LSB in this register is 1°C.

7.6.1.11 Remote Temperature Low Limit High Byte Register (offset: Read = 08h; Write = 0Eh) [reset = 00h]
Figure 26. Remote Temperature Low Limit High Byte Register

7	6	5	4	3	2	1	0
RTLL11	RTLL10	RTLL9	RTLL8	RTLL7	RTLL6	RTLL5	RTLL4
R/W-0h	R/W-0h	R/W-0h	R/W-0h	R/W-0h	R/W-0h	R/W-0h	R/W-0h

LEGEND: R/W = Read/Write; R = Read only; -n = value after reset

Table 13. Remote Temperature Low Limit High Byte Register Field Descriptions

Bit	Field	Type	Reset	Description
7 - 0	RTLL11 - RTLL4	R/W	00h	These bits determine the value of high byte of the low temperature limit to which the remote temperature measurement is compared. The resolution of the LSB in this register is 1°C.

7.6.1.12 One-shot Start Register (offset: Read = N/A; Write = 0Fh) [reset = N/A]
Figure 27. One-shot Start Register

7	6	5	4	3	2	1	0
X	X	X	X	X	X	X	X
W	W	W	W	W	W	W	W

LEGEND: R/W = Read/Write; R = Read only; -n = value after reset

Table 14. One-shot Start Register Field Descriptions

Bit	Field	Type	Reset	Description
7 - 0	X	W	N/A	When the device is in the shutdown mode writing any value to this register will trigger a one-shot temperature conversion.

7.6.1.13 Remote Temperature Low Byte Register (offset: Read = 10h; Write = N/A) [reset = 00h]

Figure 28. Remote Temperature Low Byte Register

7	6	5	4	3	2	1	0
RT3	RT2	RT1	RT0	RESERVED			
R-0h	R-0h	R-0h	R-0h	R-0h			

LEGEND: R/W = Read/Write; R = Read only; -n = value after reset

Table 15. Remote Temperature Low Byte Register Field Descriptions

Bit	Field	Type	Reset	Description
7 - 4	RT3 - RT0	R	0h	Remote temperature low byte. The resolution of the LSB in this register is 0.0625 °C. This register is read-only and is updated by the ADC each time a temperature measurement is completed. When the full temperature value is needed, reading the high byte register first causes the low byte register value to be locked (the ADC does not write to it) until it is read. The same thing happens upon reading the low byte register value first (the high byte register value is locked until it is read). This mechanism assures that both bytes of the read operation are from the same ADC conversion. This assurance remains valid only until another register is read. For proper operation, read the high byte of the temperature result first. Read the low byte register in the next read command; if the low byte is not needed, the register may be left unread. The resolution of these four bits is 0.0625 °C.

7.6.1.14 Remote Temperature Offset High Byte Register (offset: Read = 11h; Write = 11h) [reset = 00h]

Figure 29. Remote Temperature Offset High Byte Register

7	6	5	4	3	2	1	0
RTOS11	RTOS10	RTOS9	RTOS8	RTOS7	RTOS6	RTOS5	RTOS4
R/W-0h	R/W-0h	R/W-0h	R/W-0h	R/W-0h	R/W-0h	R/W-0h	R/W-0h

LEGEND: R/W = Read/Write; R = Read only; -n = value after reset

Table 16. Remote Temperature Offset High Byte Register Field Descriptions

Bit	Field	Type	Reset	Description
7 - 0	RTOS11 - RTOS4	R/W	00h	Remote temperature offset high byte. The value of this register is added to the value the ADC conversion with the result stored in the remote temperature register. This register is used to add or subtract a temperature offset value to the ADC conversion result in applications requiring calibration. The resolution of the LSB in this register is 1 °C.

The offset register allows the TMP451 device to store any system offset compensation value that might be observed from precision calibration. The value in the register is stored in the same format as the temperature result, and is added to the remote temperature result upon every conversion. Combined with the η-factor correction, this function allows for very accurate system calibration over the entire temperature range.

7.6.1.15 Remote Temperature Offset Low Byte Register (offset: Read = 12h; Write = 12h) [reset = 00h]

Figure 30. Remote Temperature Offset Low Byte Register

7	6	5	4	3	2	1	0
RTOS3	RTOS2	RTOS1	RTOS0	RESERVED			
R/W-0h	R/W-0h	R/W-0h	R/W-0h	R/W-0h			

LEGEND: R/W = Read/Write; R = Read only; -n = value after reset

Table 17. Remote Temperature Offset Low Byte Register Field Descriptions

Bit	Field	Type	Reset	Description
7 - 4	RTOS3 - RTOS0	R/W	0h	Remote temperature offset low byte. The value of this register is added to the value the ADC conversion with the result stored in the remote temperature register. This register is used to add or subtract a temperature offset value to the ADC conversion result in applications requiring calibration. The resolution of these four bits is 0.0625°C.

The offset register allows the TMP451 device to store any system offset compensation value that might be observed from precision calibration. The value in the register is stored in the same format as the temperature result, and is added to the remote temperature result upon every conversion. Combined with the η -factor correction, this function allows for very accurate system calibration over the entire temperature range.

7.6.1.16 Remote Temperature High Limit Low Byte Register (offset: Read = 13h; Write = 13h) [reset = 00h]

Figure 31. Remote Temperature High Limit Low Byte Register

7	6	5	4	3	2	1	0
RTHL3	RTHL2	RTHL1	RTHL0	RESERVED			
R/W-0h	R/W-0h	R/W-0h	R/W-0h	R/W-0h			

LEGEND: R/W = Read/Write; R = Read only; -n = value after reset

Table 18. Remote Temperature High Limit Low Byte Register Field Descriptions

Bit	Field	Type	Reset	Description
7 - 4	RTHL3 - RTHL0	R/W	0h	These bits determine the value of the low byte of the high temperature limit to which the remote temperature measurement is compared. The resolution of the four bits in this register is 0.0625°C.

7.6.1.17 Remote Temperature Low Limit Low Byte Register (offset: Read = 14h; Write = 14h) [reset = 00h]

Figure 32. Remote Temperature Low Limit Low Byte Register

7	6	5	4	3	2	1	0
RTLL3	RTLL2	RTLL1	RTLL0	RESERVED			
R/W-0h	R/W-0h	R/W-0h	R/W-0h	R/W-0h			

LEGEND: R/W = Read/Write; R = Read only; -n = value after reset

Table 19. Remote Temperature Low Limit Low Byte Register Field Descriptions

Bit	Field	Type	Reset	Description
7 - 4	RTLL3 - RTLL0	R/W	0h	These bits determine the value of the low byte of the low temperature limit to which the remote temperature measurement is compared. The resolution of the four bits in this register is 0.0625°C.

7.6.1.18 Local Temperature Low Byte Register (offset: Read = 15h; Write = N/A) [reset = 00h]

Figure 33. Local Temperature Low Byte Register

7	6	5	4	3	2	1	0
LT3	LT2	LT1	LT0	RESERVED			
R-0h	R-0h	R-0h	R-0h	R-0h			

LEGEND: R/W = Read/Write; R = Read only; -n = value after reset

Table 20. Local Temperature Low Byte Register Field Descriptions

Bit	Field	Type	Reset	Description
7 - 0	LT3 - LT0	R	0h	Local temperature low byte. The resolution of the four bits in this register is 0.0625C. This register is read-only and is updated by the ADC each time a temperature measurement is completed. When the full temperature value is needed, reading the high byte register first causes the low byte register value to be locked (the ADC does not write to it) until it is read. The same thing happens upon reading the low byte register value first (the high byte register value is locked until it is read). This mechanism assures that both bytes of the read operation are from the same ADC conversion. This assurance remains valid only until another register is read. For proper operation, read the high byte of the temperature result first. Read the low byte register in the next read command; if the low byte is not needed, the register may be left unread.

7.6.1.19 Remote Temperature THERM Limit Register (offset: Read = 19h; Write = 19h) [reset = 6C]

Figure 34. Remote Temperature THERM Limit Register

7	6	5	4	3	2	1	0
RTH11	RTH10	RTH9	RTH8	RTH7	RTH6	RTH5	RTH4
R/W-0h	R/W-1h	R/W-1h	R/W-0h	R/W-1h	R/W-1h	R/W-0h	R/W-0h

LEGEND: R/W = Read/Write; R = Read only; -n = value after reset

Table 21. Remote Temperature THERM Limit Register Field Descriptions

Bit	Field	Type	Reset	Description
7 - 0	RTH11 - RTH4	R/W	6Ch	Remote temperature THERM limit. These bits determine the value of the THERM limit to which the remote temperature measurement is compared. The resolution of the LSB in this register is 1 °C.

7.6.1.20 Local Temperature THERM Limit Register (offset: Read = 20h; Write = 20h) [reset = 55]

Figure 35. Local Temperature THERM Limit Register

7	6	5	4	3	2	1	0
LTH11	LTH10	LTH9	LTH8	LTH7	LTH6	LTH5	LTH4
R/W-0h	R/W-1h	R/W-0h	R/W-1h	R/W-0h	R/W-1h	R/W-0h	R/W-1h

LEGEND: R/W = Read/Write; R = Read only; -n = value after reset

Table 22. Local Temperature THERM Limit Register Field Descriptions

Bit	Field	Type	Reset	Description
7 - 0	LTH11 - LTH4	R/W	55h	Local temperature THERM limit. These bits determine the value of the THERM limit to which the local temperature measurement is compared. The resolution of the LSB in this register is 1 °C.

7.6.1.21 THERM Hysteresis Register (offset: Read = 21h; Write = 21h) [reset = 0Ah]

Figure 36. THERM Hysteresis Register

7	6	5	4	3	2	1	0
HYS11	HYS10	HYS9	HYS8	HYS7	HYS6	HYS5	HYS4
R/W-0h	R/W-0h	R/W-0h	R/W-0h	R/W-1h	R/W-0h	R/W-1h	R/W-0h

LEGEND: R/W = Read/Write; R = Read only; -n = value after reset

Table 23. THERM Hysteresis Register Field Descriptions

Bit	Field	Type	Reset	Description
7 - 0	HYS11 - HYS4	R/W	0Ah	THERM hysteresis value. These bits determine the amount of hysteresis applied to the THERM function. The resolution of the LSB in this register is 1 °C.

7.6.1.22 Consecutive ALERT Register (offset: Read = 22h; Write = 22h) [reset = 01h]

Figure 37. Consecutive ALERT Register

7	6	5	4	3	2	1	0
SMBTO	RESERVED		CONAL2	CONAL1	CONAL0	RESERVED	
R/W-0h	R/W-0h		R/W-0h	R/W-0h	R/W-0h	R/W-1h	

LEGEND: R/W = Read/Write; R = Read only; -n = value after reset

Table 24. Consecutive ALERT Register Field Descriptions

Bit	Field	Type	Reset	Description
7	SMBTO	R/W	0h	SMBus time-out enable or disable. Refer to Time-out Function 1 = Enables the SMBus time-out feature. 0 = Disables the SMBus time-out feature.
3 - 1	CONAL2 - CONAL1	R/W	0h	Number of consecutive out-of-limit measurements required to activate the ALERT flag and pin Refer to Table 25

Table 25. Consecutive Alert Configuration

VALUE	Number of Consecutive Out-of-limit Measurements Required
0h	1
1h	2
3h	3
7h	4

7.6.1.23 η-Factor Correction Register (offset: Read = 23h; Write = 23h) [reset = 00h]

Figure 38. η-Factor Correction Register

7	6	5	4	3	2	1	0
NC7	NC6	NC5	NC4	NC3	NC2	NC1	NC0
R/W-0h	R/W-0h	R/W-0h	R/W-0h	R/W-0h	R/W-0h	R/W-0h	R/W-0h

LEGEND: R/W = Read/Write; R = Read only; -n = value after reset

Table 26. η-Factor Correction Register Field Descriptions

Bit	Field	Type	Reset	Description
7 - 0	NC7 - NC0	R/W	00h	η-factor value Refer to Table 27

The TMP451 device allows for a different η -factor value to be used for converting remote channel measurements to temperature. The remote channel uses sequential current excitation to extract a differential V_{BE} voltage measurement to determine the temperature of the remote transistor. Equation 1 shows this voltage and temperature.

$$V_{BE2} - V_{BE1} = \frac{\eta k T}{q} \ln \left(\frac{I_2}{I_1} \right) \tag{1}$$

The value η in Equation 1 is a characteristic of the particular transistor used for the remote channel. The power-on reset value for the TMP451 device is $\eta = 1.008$. The value in the η -factor correction register may be used to adjust the effective η -factor according to Equation 2 and Equation 3.

$$\eta_{\text{eff}} = \left(\frac{1.008 \times 2088}{2088 + N_{\text{ADJUST}}} \right) \tag{2}$$

$$N_{\text{ADJUST}} = \left(\frac{1.008 \times 2088}{\eta_{\text{eff}}} \right) - 2088 \tag{3}$$

The η -factor correction value must be stored in twos complement format, yielding an effective data range from -128 to 127. The η -factor correction value is written to and read from pointer address 23h. The register power-on reset value is 00h, thus having no effect unless a different value is written to it.

Table 27. η -Factor Range

BINARY	N _{ADJUST}		η
	HEX	DECIMAL	
0111 1111	7F	127	0.950198
0000 1010	0A	10	1.003195
0000 1000	08	8	1.004152
0000 0110	06	6	1.005111
0000 0100	04	4	1.006072
0000 0010	02	2	1.007035
0000 0001	01	1	1.007517
0000 0000	00	0	1.008
1111 1111	FF	-1	1.008483
1111 1110	FE	-2	1.008967
1111 1100	FC	-4	1.009935
1111 1010	FA	-6	1.010905
1111 1000	F8	-8	1.011877
1111 0110	F6	-10	1.012851
1000 0000	80	-128	1.073837

7.6.1.24 Digital Filter Control Register (offset: Read = 24h; Write = 24h) [reset = 00h]

Figure 39. Digital Filter Control Register

7	6	5	4	3	2	1	0
RESERVED						DF1	DF0
R/W-0h						R/W-0h	R/W-0h

LEGEND: R/W = Read/Write; R = Read only; -n = value after reset

Table 28. Digital Filter Control Register Field Descriptions

Bit	Field	Type	Reset	Description
1 - 0	DF1 - DF0	R/W	0h	Configures the amount of filtering for the remote temperature results. Refer to Table 29

Table 29. Digital Filter Configuration

VALUE	Number of Remote Temperature Measurements Averaged
0h	Averaging off
1h	4
2h	8
4h	not used

7.6.1.25 Manufacturer ID Register (offset: Read = FEh; Write = N/A) [reset = 55]
Figure 40. Manufacturer ID Register

7	6	5	4	3	2	1	0
ID7	ID6	ID5	ID4	ID3	ID2	ID1	ID0
R-0h	R-1h	R-0h	R-1h	R-0h	R-1h	R-0h	R-1h

LEGEND: R/W = Read/Write; R = Read only; -n = value after reset

Table 30. Manufacturer ID Register Field Descriptions

Bit	Field	Type	Reset	Description
7 - 0	ID7 - ID0	R	55h	Manufacturer identification information

The TMP451 device allows for the two-wire bus controller to query the device for manufacturer and device IDs to enable software identification of the device at the particular two-wire bus address. The manufacturer ID is obtained by reading from pointer address FEh. The TMP451 device reads 55h for the manufacturer code.



8 Application and Implementation

NOTE

Information in the following applications sections is not part of the TI component specification, and TI does not warrant its accuracy or completeness. TI's customers are responsible for determining suitability of components for their purposes. Customers should validate and test their design implementation to confirm system functionality.

8.1 Application Information

The TMP451 device requires only a transistor connected between the D+ and D– pins for remote temperature measurement. Tie the D+ pin to GND if the remote channel is not used and only the local temperature is measured. The SDA, ALERT, and THERM pins (and SCL, if driven by an open-drain output) require pullup resistors as part of the communication bus. A 0.1- μ F power-supply decoupling capacitor is recommended for local bypassing.

8.2 Typical Application

Figure 41 shows the typical configuration for the TMP451 device.

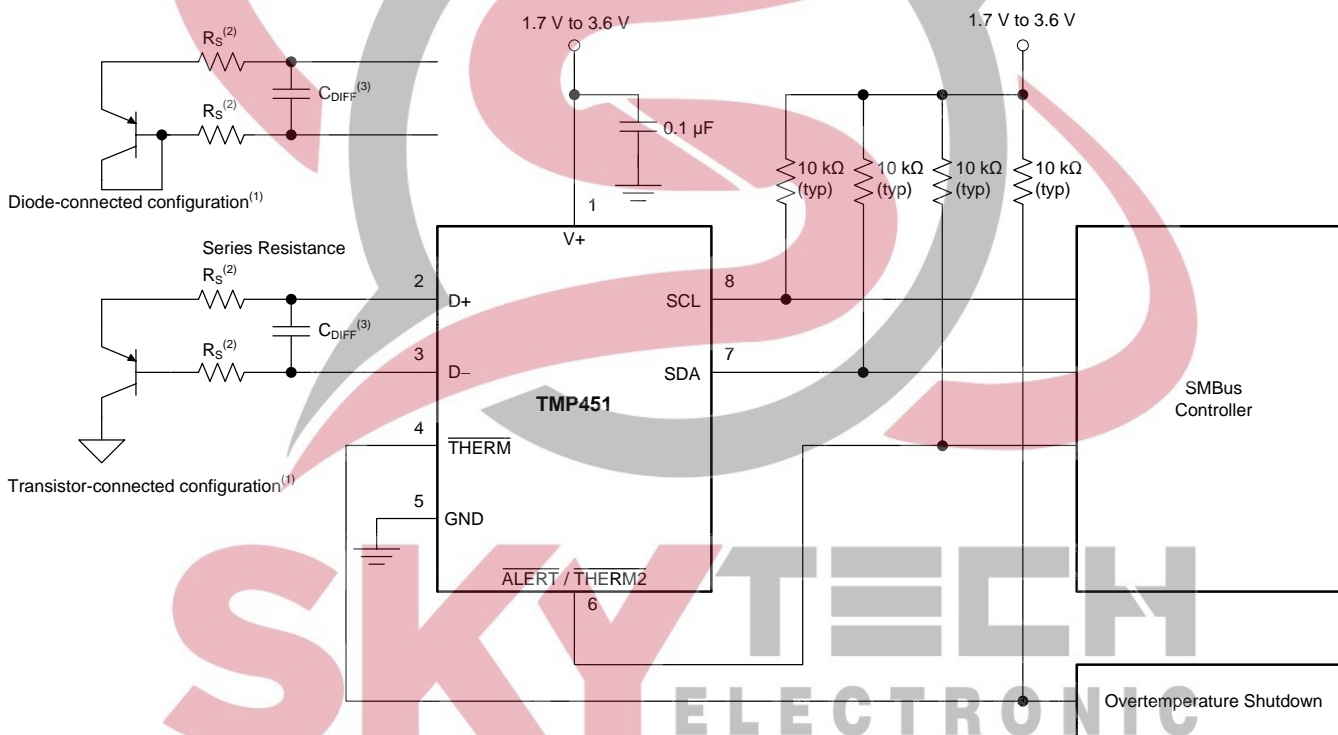

(1) Diode-connected configuration provides better settling time. Transistor-connected configuration provides better series resistance cancellation.

(2) R_S (optional) should be < 1 k Ω in most applications. Selection of R_S depends on application; see the [Filtering](#) section.

(3) C_{DIFF} (optional) should be < 1000 pF in most applications. Selection of C_{DIFF} depends on application; see the [Filtering](#) section and [Figure 6](#).

Figure 41. TMP451 Basic Connections Using a Discrete Remote Transistor

Typical Application (continued)

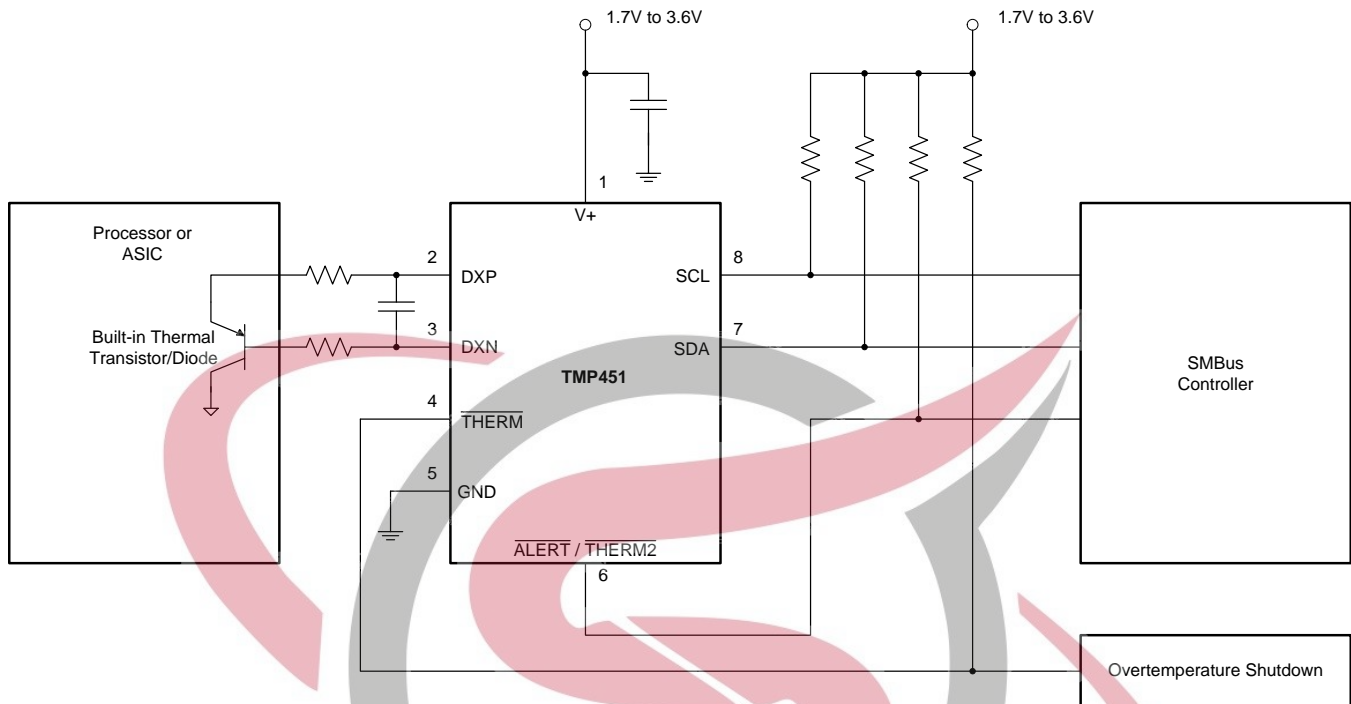

Figure 42. TMP451 Basic Connections Using a Processor Built-In Remote Transistor

8.2.1 Design Requirements

The TMP451 device is designed to be used with either discrete transistors or substrate transistors built into processor chips and ASICs. Either NPN or PNP transistors can be used, as long as the base-emitter junction is used as the remote temperature sense. NPN transistors must be diode-connected. PNP transistors can either be transistor- or diode-connected (see Figure 41).

Errors in remote temperature sensor readings are typically the consequence of the ideality factor and current excitation used by the TMP451 device versus the manufacturer-specified operating current for a given transistor. Some manufacturers specify a high-level and low-level current for the temperature-sensing substrate transistors. The TMP451 device uses 7.5 μA for I_{LOW} and 120 μA for I_{HIGH}.

The ideality factor (η) is a measured characteristic of a remote temperature sensor diode as compared to an ideal diode. The TMP451 allows for different η-factor values; see the η-Factor Correction Register section.

The ideality factor for the TMP451 device is trimmed to be 1.008. For transistors that have an ideality factor that does not match the TMP451, Equation 4 can be used to calculate the temperature error.

NOTE

For the equation to be used correctly, actual temperature (°C) must be converted to Kelvin (K).

$$T_{ERR} = \left(\frac{\eta - 1.008}{1.008} \right) \times (273.15 + T(^{\circ}C))$$

where

- T_{ERR} = error in the TMP451 device because η ≠ 1.008
- η = ideality factor of remote temperature sensor
- T(°C) = actual temperature
- Degree delta is the same for °C and K.

(4)

Typical Application (continued)

For $\eta = 1.004$ and $T(^{\circ}\text{C}) = 100^{\circ}\text{C}$:

$$T_{\text{ERR}} = \left(\frac{1.004 - 1.008}{1.008} \right) \times (273.15 + 100^{\circ}\text{C})$$

$$T_{\text{ERR}} = 1.48^{\circ}\text{C} \quad (5)$$

If a discrete transistor is used as the remote temperature sensor with the TMP451, the best accuracy can be achieved by selecting the transistor according to the following criteria:

1. Base-emitter voltage $> 0.25\text{ V}$ at $7.5\ \mu\text{A}$, at the highest sensed temperature.
2. Base-emitter voltage $< 0.95\text{ V}$ at $120\ \mu\text{A}$, at the lowest sensed temperature.
3. Base resistance $< 100\ \Omega$.
4. Tight control of V_{BE} characteristics indicated by small variations in h_{FE} (that is, 50 to 150).

Based on this criteria, two recommended small-signal transistors are the 2N3904 (NPN) or 2N3906 (PNP).

8.2.2 Detailed Design Procedure

The local temperature sensor inside the TMP451 device monitors the ambient air around the device. The thermal time constant for the TMP451 device is approximately two seconds. This constant implies that if the ambient air changes quickly by 100°C , it would take the TMP451 device about 10 seconds (that is, five thermal time constants) to settle to within 1°C of the final value. In most applications, the TMP451 package is in electrical, and therefore thermal, contact with the printed circuit board (PCB), as well as subjected to forced airflow. The accuracy of the measured temperature directly depends on how accurately the PCB and forced airflow temperatures represent the temperature that the TMP451 is measuring. Additionally, the internal power dissipation of the TMP451 can cause the temperature to rise above the ambient or PCB temperature. The internal power dissipated as a result of exciting the remote temperature sensor is negligible because of the small currents used. For a 3.3-V supply and maximum conversion rate of 16 conversions per second, the TMP451 device dissipates 0.54 mW ($\text{PD}_{\text{IQ}} = 3.3\text{ V} \times 165\ \mu\text{A}$). A θ_{JA} of $171.3^{\circ}\text{C}/\text{W}$ causes the junction temperature to rise approximately 0.09°C above the ambient.

The temperature measurement accuracy of the TMP451 device depends on the remote and/or local temperature sensor being at the same temperature as the system point being monitored. Clearly, if the temperature sensor is not in good thermal contact with the part of the system being monitored, then there will be a delay in the response of the sensor to a temperature change in the system. For remote temperature-sensing applications using a substrate transistor (or a small, SOT23 transistor) placed close to the device being monitored, this delay is usually not a concern.

8.2.3 Application Curves

The following curves show the performance capabilities of the TMP451 device. [Figure 43](#) shows the accuracy performance in an oil-bath temperature drift of a population of 16 standard 2N3906 transistors measured in a diode-connected configuration. [Figure 44](#) shows the typical step response to a submerging of a sensor in an oil bath with temperature of 100°C .

Typical Application (continued)

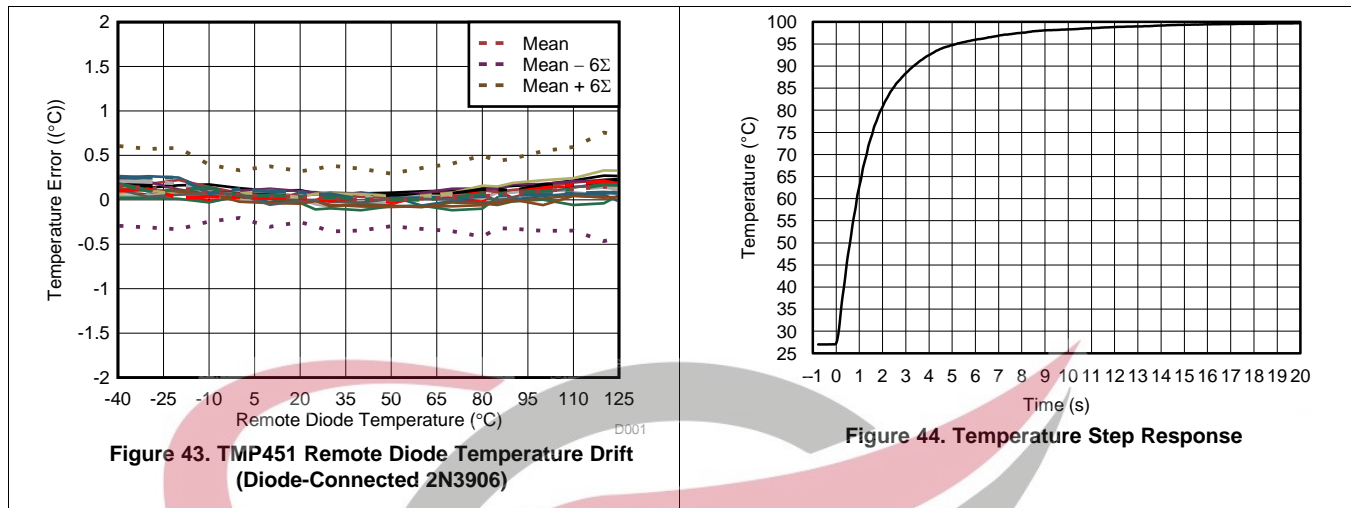

9 Power Supply Recommendations

The TMP451 device operates with a power supply range of 1.7 V to 3.6 V. The device is optimized for operation at 3.3-V supply but can measure temperature accurately in the full supply range.

A power-supply bypass capacitor is recommended. Place this capacitor as close as possible to the supply and ground pins of the device. A typical value for this supply bypass capacitor is 0.1 μF. Applications with noisy or high-impedance power supplies may require additional decoupling capacitors to reject power-supply noise.

10 Layout

10.1 Layout Guidelines

Remote temperature sensing on the TMP451 device measures very small voltages using very low currents; therefore, noise at the device inputs must be minimized. Most applications using the TMP451 have high digital content, with several clocks and logic level transitions creating a noisy environment. Layout should adhere to the following guidelines:

1. Place the TMP451 device as close to the remote junction sensor as possible.
2. Route the D+ and D– traces next to each other and shield them from adjacent signals through the use of ground guard traces; see Figure 45. If a multilayer PCB is used, bury these traces between ground or V+ planes to shield them from extrinsic noise sources. 5 mil (0.127 mm) PCB traces are recommended.
3. Minimize additional thermocouple junctions caused by copper-to-solder connections. If these junctions are used, make the same number and approximate locations of copper-to-solder connections in both the D+ and D– connections to cancel any thermocouple effects.
4. Use a 0.1μF local bypass capacitor directly between the V+ and GND of the TMP451 device. For optimum measurement performance, minimize filter capacitance between D+ and D– to 1000 pF or less . This capacitance includes any cable capacitance between the remote temperature sensor and the TMP451 device.
5. If the connection between the remote temperature sensor and the TMP451 device is less than 8-in (20,32 cm) long, use a twisted-wire pair connection. For lengths greater than 8 in, use a twisted, shielded pair with the shield grounded as close to the TMP451 device as possible. Leave the remote sensor connection end of the shield wire open to avoid ground loops and 60-Hz pickup.
6. Thoroughly clean and remove all flux residue in and around the pins of the TMP451 device to avoid temperature offset readings as a result of leakage paths between D+ and GND, or between D+ and V+.

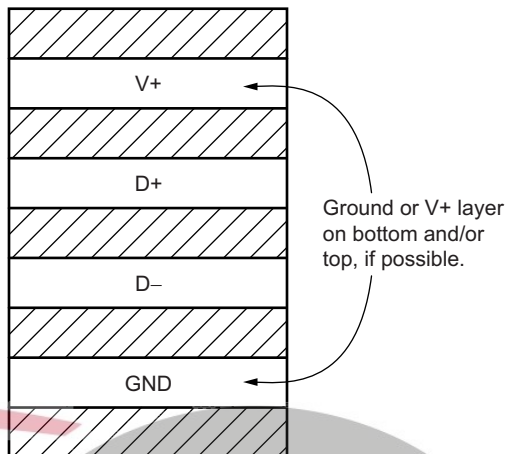

Use minimum 5-mil (0.127 mm) traces with 5-mil spacing.

Figure 45. Suggested PCB Layer Cross-Section

10.2 Layout Example

- VIA to Power or Ground Plane
- ⊖ VIA to Internal Layer

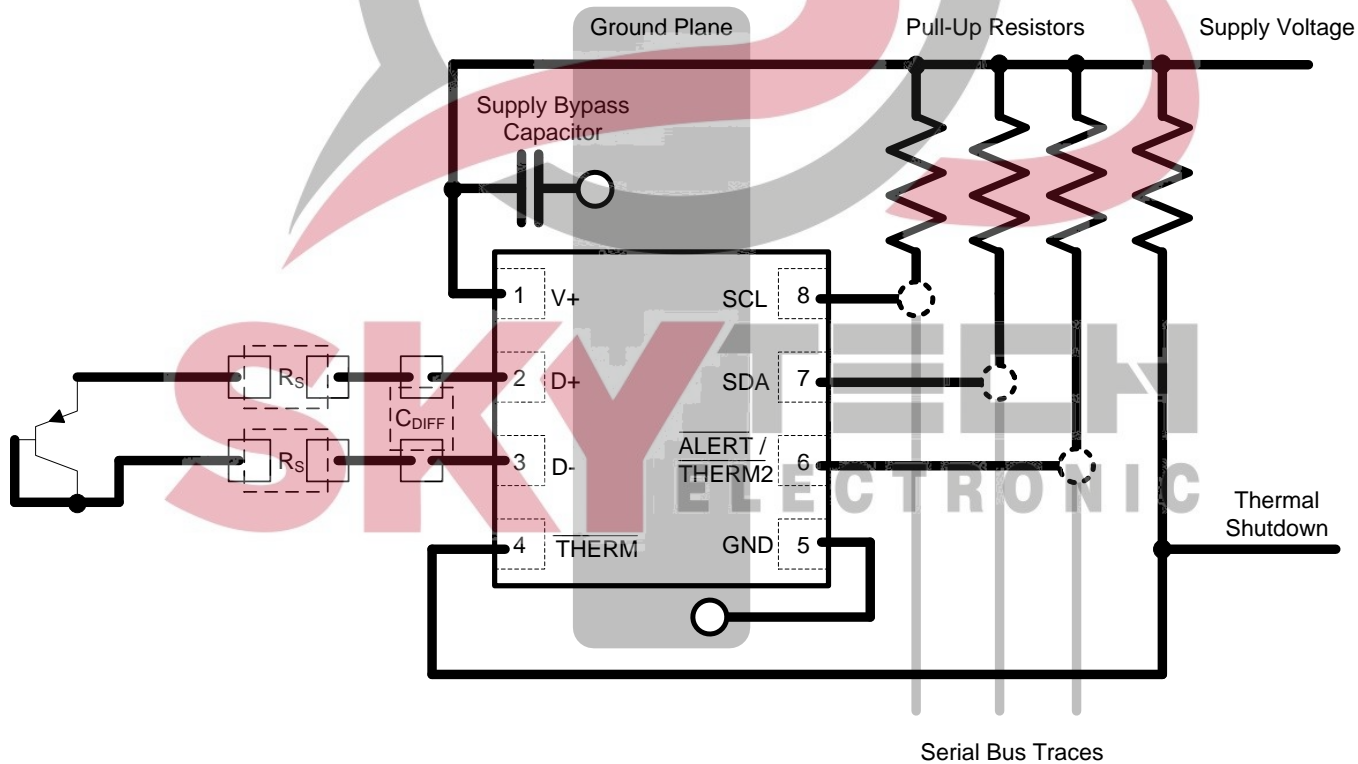

Figure 46. TMP451 Layout Example

11 Device and Documentation Support

11.1 Trademarks

SMBus is a trademark of Intel Corporation. All other trademarks are the property of their respective owners.

11.2 Electrostatic Discharge Caution



This integrated circuit can be damaged by ESD. Texas Instruments recommends that all integrated circuits be handled with appropriate precautions. Failure to observe proper handling and installation procedures can cause damage.

ESD damage can range from subtle performance degradation to complete device failure. Precision integrated circuits may be more susceptible to damage because very small parametric changes could cause the device not to meet its published specifications.

11.3 Glossary

[SLYZ022](#) — *TI Glossary*.



This glossary lists and explains terms, acronyms, and definitions.

12 Mechanical, Packaging, and Orderable Information

The following pages include mechanical, packaging, and orderable information. This information is the most current data available for the designated devices. This data is subject to change without notice and revision of this document. For browser-based versions of this data sheet, refer to the left-hand navigation.



PACKAGING INFORMATION

Orderable Device	Status (1)	Package Type	Package Drawing	Pins	Package Qty	Eco Plan (2)	Lead/Ball Finish (6)	MSL Peak Temp (3)	Op Temp (°C)	Device Marking (4/5)	Samples
TMP451AIDQFR	ACTIVE	WS0N	DQF	8	3000	Green (RoHS & no Sb/Br)	NIPDAU	Level-1-260C-UNLIM	-40 to 125	T451	
TMP451AIDQFT	ACTIVE	WS0N	DQF	8	250	Green (RoHS & no Sb/Br)	NIPDAU	Level-1-260C-UNLIM	-40 to 125	T451	

(1) The marketing status values are defined as follows:

ACTIVE: Product device recommended for new designs.

LIFEBUY: TI has announced that the device will be discontinued, and a lifetime-buy period is in effect.

NRND: Not recommended for new designs. Device is in production to support existing customers, but TI does not recommend using this part in a new design.

PREVIEW: Device has been announced but is not in production. Samples may or may not be available.

OBSELETE: TI has discontinued the production of the device.

(2) **RoHS:** TI defines "RoHS" to mean semiconductor products that are compliant with the current EU RoHS requirements for all 10 RoHS substances, including the requirement that RoHS substance do not exceed 0.1% by weight in homogeneous materials. Where designed to be soldered at high temperatures, "RoHS" products are suitable for use in specified lead-free processes. TI may reference these types of products as "Pb-Free".

RoHS Exempt: TI defines "RoHS Exempt" to mean products that contain lead but are compliant with EU RoHS pursuant to a specific EU RoHS exemption.

Green: TI defines "Green" to mean the content of Chlorine (Cl) and Bromine (Br) based flame retardants meet JS709B low halogen requirements of <=1000ppm threshold. Antimony trioxide based flame retardants must also meet the <=1000ppm threshold requirement.

(3) MSL, Peak Temp. - The Moisture Sensitivity Level rating according to the JEDEC industry standard classifications, and peak solder temperature.

(4) There may be additional marking, which relates to the logo, the lot trace code information, or the environmental category on the device.

(5) Multiple Device Markings will be inside parentheses. Only one Device Marking contained in parentheses and separated by a "~" will appear on a device. If a line is indented then it is a continuation of the previous line and the two combined represent the entire Device Marking for that device.

(6) Lead/Ball Finish - Orderable Devices may have multiple material finish options. Finish options are separated by a vertical ruled line. Lead/Ball Finish values may wrap to two lines if the finish value exceeds the maximum column width.

Important Information and Disclaimer:The information provided on this page represents TI's knowledge and belief as of the date that it is provided. TI bases its knowledge and belief on information provided by third parties, and makes no representation or warranty as to the accuracy of such information. Efforts are underway to better integrate information from third parties. TI has taken and continues to take reasonable steps to provide representative and accurate information but may not have conducted destructive testing or chemical analysis on incoming materials and chemicals. TI and TI suppliers consider certain information to be proprietary, and thus CAS numbers and other limited information may not be available for release.

In no event shall TI's liability arising out of such information exceed the total purchase price of the TI part(s) at issue in this document sold by TI to Customer on an annual basis.

OTHER QUALIFIED VERSIONS OF TMP451 :

- Automotive: [TMP451-Q1](#)

NOTE: Qualified Version Definitions:

- Automotive - Q100 devices qualified for high-reliability automotive applications targeting zero defects



TAPE AND REEL INFORMATION

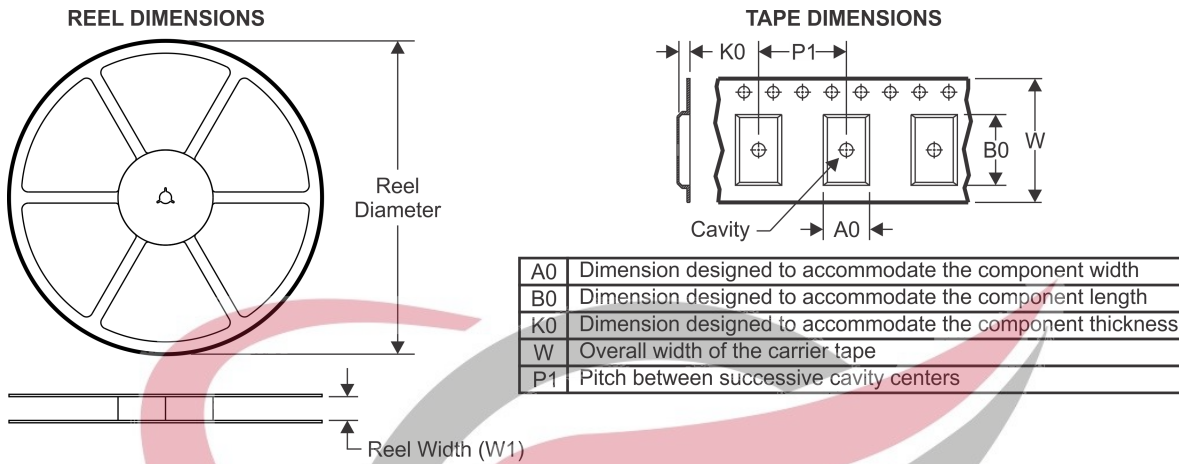

QUADRANT ASSIGNMENTS FOR PIN 1 ORIENTATION IN TAPE

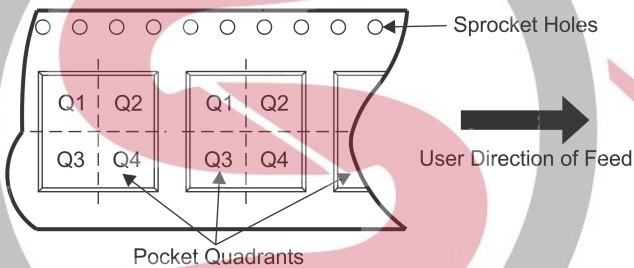

*All dimensions are nominal

Device	Package Type	Package Drawing	Pins	SPQ	Reel Diameter (mm)	Reel Width W1 (mm)	A0 (mm)	B0 (mm)	K0 (mm)	P1 (mm)	W (mm)	Pin1 Quadrant
TMP451AIDQFR	WSON	DQF	8	3000	180.0	8.4	2.3	2.3	1.15	4.0	8.0	Q2
TMP451AIDQFR	WSON	DQF	8	3000	180.0	8.4	2.2	2.2	1.2	4.0	8.0	Q2
TMP451AIDQFT	WSON	DQF	8	250	180.0	8.4	2.2	2.2	1.2	4.0	8.0	Q2



TAPE AND REEL BOX DIMENSIONS

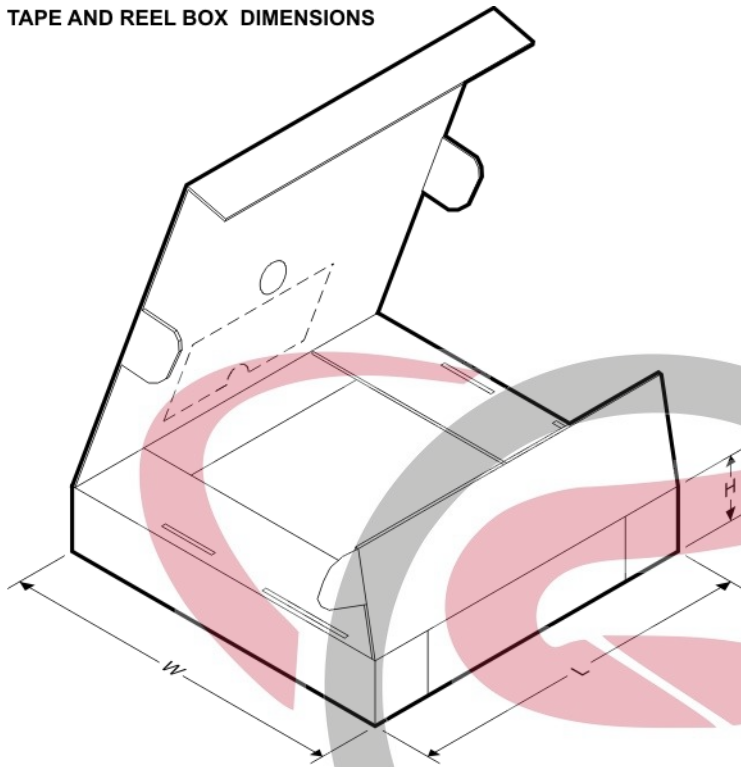

*All dimensions are nominal

Device	Package Type	Package Drawing	Pins	SPQ	Length (mm)	Width (mm)	Height (mm)
TMP451AIDQFR	WSON	DQF	8	3000	210.0	185.0	35.0
TMP451AIDQFR	WSON	DQF	8	3000	203.0	203.0	35.0
TMP451AIDQFT	WSON	DQF	8	250	203.0	203.0	35.0

SKYTECH
ELECTRONIC

DQF (S-PWSON-N8)

PLASTIC SMALL OUTLINE NO-LEAD

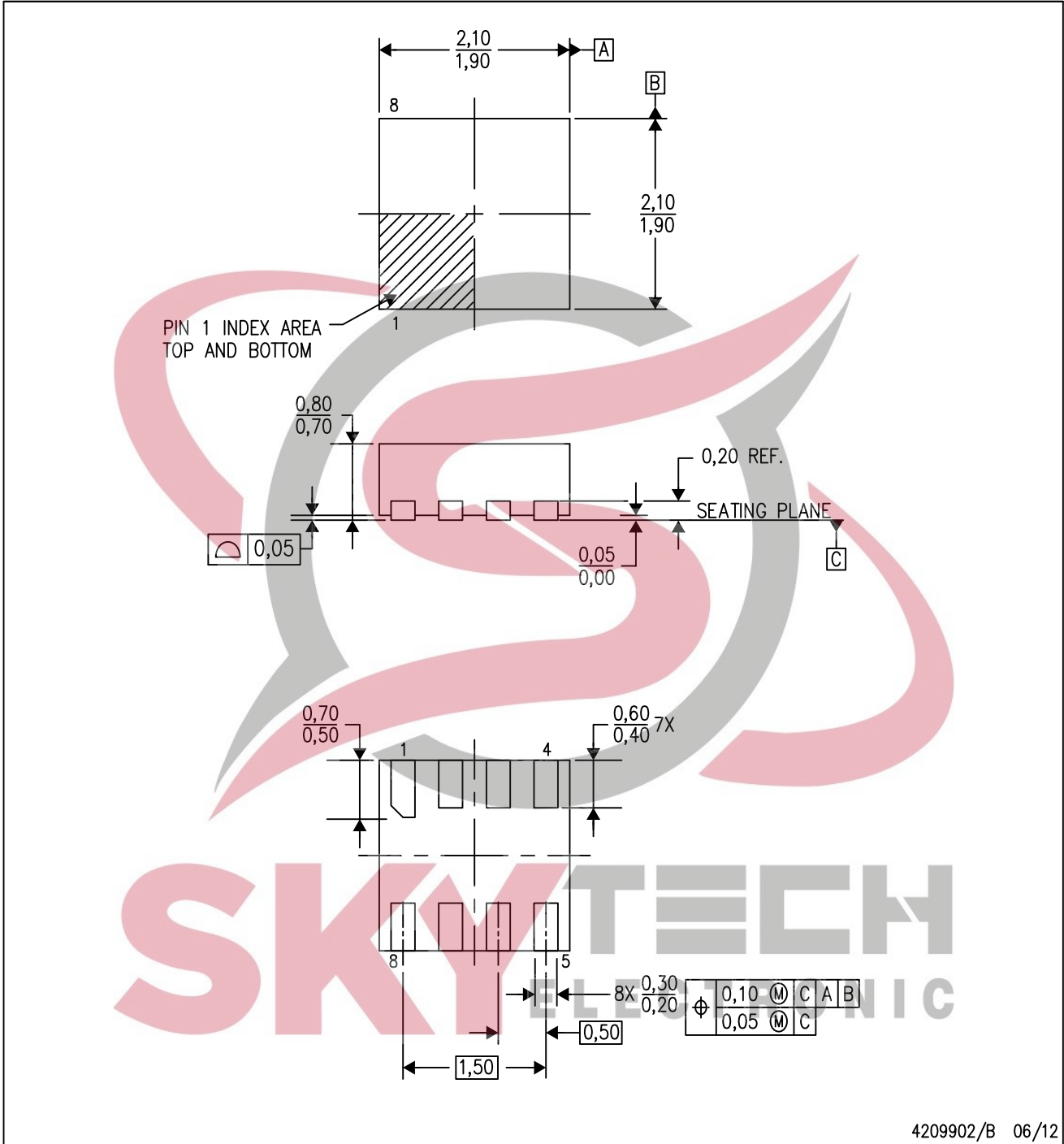

4209902/B 06/12

- NOTES:
- A. All linear dimensions are in millimeters. Dimensioning and tolerancing per ASME Y14.5M-1994.
 - B. This drawing is subject to change without notice.
 - C. SON (Small Outline No-Lead) package configuration.

DQF (S-PWSON-N8)

PLASTIC SMALL OUTLINE NO-LEAD

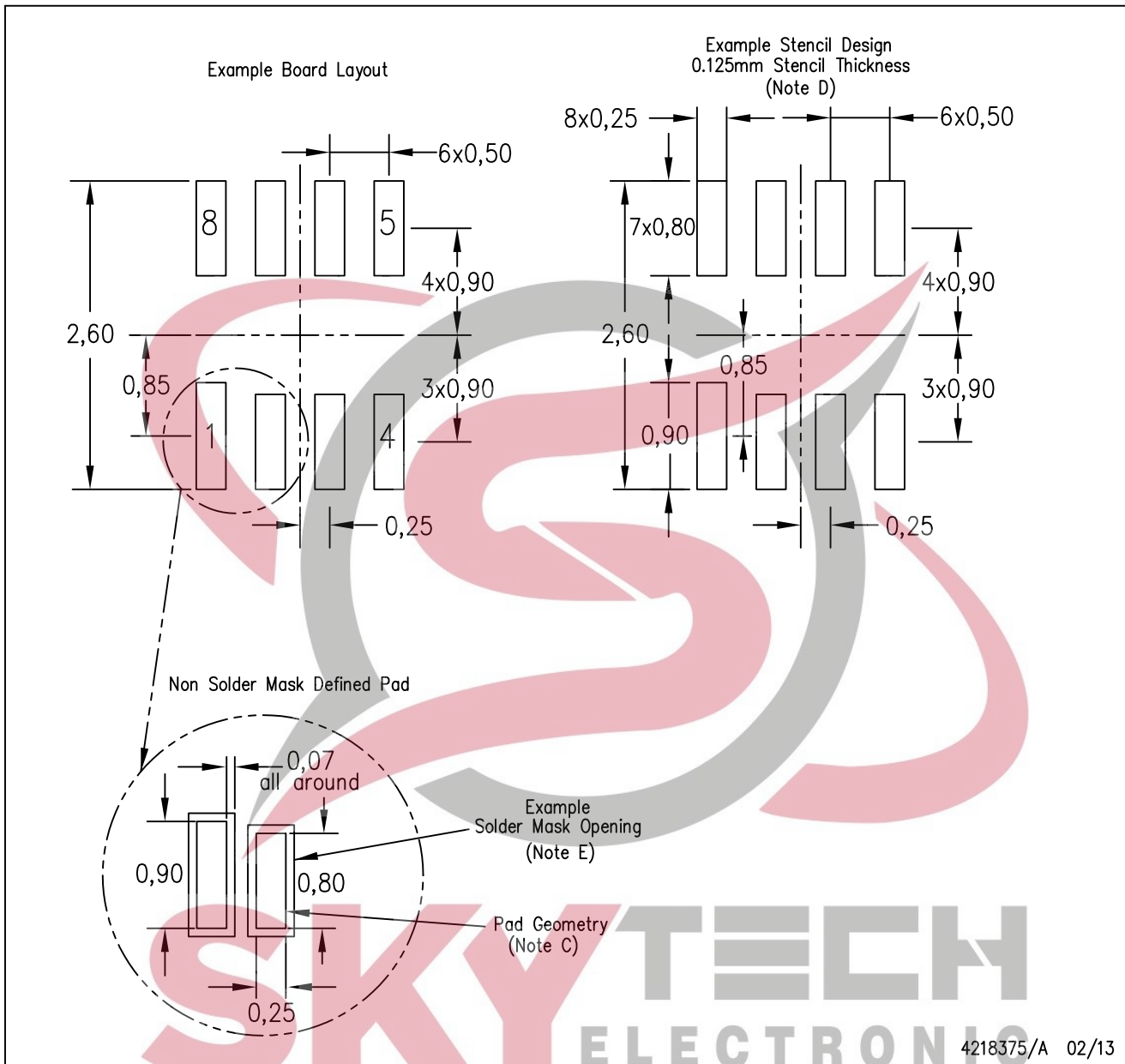

- NOTES:
- A. All linear dimensions are in millimeters.
 - B. This drawing is subject to change without notice.
 - C. Publication IPC-7351 is recommended for alternate designs.
 - D. Laser cutting apertures with trapezoidal walls and also rounding corners will offer better paste release. Customers should contact their board assembly site for stencil design recommendations. Refer to IPC 7525 for stencil design considerations.
 - E. Customers should contact their board fabrication site for solder mask tolerances.

IMPORTANT NOTICE AND DISCLAIMER

TI PROVIDES TECHNICAL AND RELIABILITY DATA (INCLUDING DATASHEETS), DESIGN RESOURCES (INCLUDING REFERENCE DESIGNS), APPLICATION OR OTHER DESIGN ADVICE, WEB TOOLS, SAFETY INFORMATION, AND OTHER RESOURCES "AS IS" AND WITH ALL FAULTS, AND DISCLAIMS ALL WARRANTIES, EXPRESS AND IMPLIED, INCLUDING WITHOUT LIMITATION ANY IMPLIED WARRANTIES OF MERCHANTABILITY, FITNESS FOR A PARTICULAR PURPOSE OR NON-INFRINGEMENT OF THIRD PARTY INTELLECTUAL PROPERTY RIGHTS.

These resources are intended for skilled developers designing with TI products. You are solely responsible for (1) selecting the appropriate TI products for your application, (2) designing, validating and testing your application, and (3) ensuring your application meets applicable standards, and any other safety, security, or other requirements. These resources are subject to change without notice. TI grants you permission to use these resources only for development of an application that uses the TI products described in the resource. Other reproduction and display of these resources is prohibited. No license is granted to any other TI intellectual property right or to any third party intellectual property right. TI disclaims responsibility for, and you will fully indemnify TI and its representatives against, any claims, damages, costs, losses, and liabilities arising out of your use of these resources.

TI's products are provided subject to TI's Terms of Sale (www.ti.com/legal/termsofsale.html) or other applicable terms available either on ti.com or provided in conjunction with such TI products. TI's provision of these resources does not expand or otherwise alter TI's applicable warranties or warranty disclaimers for TI products.

Mailing Address: Texas Instruments, Post Office Box 655303, Dallas, Texas 75265
Copyright © 2020, Texas Instruments Incorporated



SKYTECH
ELECTRONIC